

# STIGA

A woman wearing a yellow safety helmet and a black safety harness is using a STIGA SMT 48 AE trimmer head on a tree. She is wearing a white t-shirt and dark pants. The background is a lush green tree with a blue sky. The STIGA logo is visible on the trimmer head.

***SPARE PARTS AND ACCESSORIES  
2015***

# Spare Parts and Accessories 2015

## Robot Mowers

Care	7
Electronics	7
Wheels	8
Blades	8
Lithium Batteries & Chargers	9
Installation	9



## Chain Saws

Chains	11
Files & Filing Kit	11



## Brush Cutters & Trimmers

Trimmer Heads	13
Trimmer Lines	14
Blades	15
Batteries & Chargers	15



## Lawn Mowers

Blade Holders	17
Blades	18
Belts	20
Lithium Batteries & Chargers	21
Starter Batteries & Chargers	21
Care	21



## Front Mowers

Blades	23
Blade Holders	24
Belts	25
Starter Batteries & Chargers	27
Steering Wires	27



## Lawn Tractors

Belts	29
Blades	30
Blade Holders	31
Starter Batteries & Chargers	31
Care	31



## Snow Throwers, Scarifiers, Tillers

Belts	33
-------	----



## Engine Parts

Filters	35
Spark Plugs	35



## Lubricants & Cans

Chain Oil	37
2 Stroke Oil	37
4 Stroke Oil	37
Transmission Oil	38
Cans	38



## Technical Section

Technical section	40
-------------------	----



# Official Genuine Parts

*This wide range of Stiga Spare Parts and Accessories is developed building on the long experience of Stiga in manufacturing and development of garden machinery, and it is suitable for all Stiga machines*

*Developed together with the machines, these accessories enable you to always get high performances in total safety. Strict tests, careful checks during all the processes, high quality of the raw material used and the perfect applicability on the machines are the fundamental elements which make STIGA Spare Parts and Accessories different from other general after-market products.*

*Only original STIGA Spare Parts and Accessories are tested and approved by the home-factory ensuring total safety during use, especially for potentially dangerous parts, such as blades. For these reasons, during all the maintenance activities, it is fundamental to verify that the broken or damaged part is substituted only by original STIGA Spare Parts and Accessories.*

*All the technical and fitting information can be easily found in the present catalogue.*

*STIGA Spare Parts and Accessories: Guaranteed quality and safety.*

Info at:

**SPD**  
**Spare Parts Documents\***  
[spareparts.ggp-group.com](http://spareparts.ggp-group.com)

**SPT**  
**Spare Parts Tools\***  
[www.ggppartsandservice.com](http://www.ggppartsandservice.com)

*\* log-in and password are required. Contact your Stiga referent to get your credentials.*

*Stiga reserves the right of making both technical and aesthetic changes to the products without notice.*

**NOTICE**  = This column is your reading starting reference

# *Robot Mowers*



# Care

Stiga offers a waterproof **cover**, which allows protection of the recharging base in total safety if it has to stay outdoors. It can be adapted to the robot itself. The **charging base cover**, instead, protects the robot from all atmospheric agents, like sun and rain. It's easy to assemble/disassemble in case of ordinary maintenance or cleaning operations. Designed to join functionality (the correct fresh air flow is assured by the front and side windows, while its shape allows the easy access to the keypad without removing the robot from charge) and aesthetic (an unmistakable Stiga "sign" will stuck in your garden for all the cutting season).



1



2

## Packaging

DIMENSIONS: 15,4x21x6,5 cm  
GROSS WEIGHT: 0,240 kg

Code	EAN	Pos	Description	Fits for	Measures cm	Info	Note
1126-9150-01	7313329260547	1	Protective cover	125 - 127 - 145 - 325 - 328S	60 x 50 x 35	Protect the charging station against sun, ice, rain, dust	Stiga pack
1126-9164-01	7313329620594	2	Charging base cover	223 - 225S	53,4 x 51,6 x 33,5	Screws are included	Neutral pack

# Electronics

The sophisticated high-tech Autoclip range of robots offer several advantages and accessories. The **SMS modules** allow installers to check remotely on the Robot's daily tasks and performance. The **Compass** option checks on directional movement of the robot while it works over difficult terrain. The **USB bluetooth** convertor connects your PC and the Robot. The **bluetooth receiver** enables wireless software updates via the Stiga Client. Stiga provides a **remote control** in order to «guide» the robot manually, over-riding its own programming.



1



2



3



4



5



6

Code	EAN	Pos	Description	Fits for	Info	Note
1126-9142-01	7313329260462	1	Sms module (gsm-gprs)	328S - 524S - 527S - 720S	For prof. users	Neutral pack
1126-9154-01	7313329260608	2	Cube board (compass)	527S - 720S (— 2014)	For prof. users	Neutral pack
1126-9152-01	7313329260561	3	Usb bluetooth converter	125 - 127 - 140 - 145 - 223 - 225S - 325 - 328S - 520 - 522 - 523 - 524S - 525 - 525S - 527 - 527S - 720S	To be use with bluetooth receiver	Neutral pack
1126-9125-01	7313329260301	4	Remote control	520 - 523 - 525	Kit composed by mother board and receiver.	Neutral pack
1126-9135-01	7313329260394	5	Bluetooth console	125 - 127 - 223 - 225S - 325 - 328S - 520 - 522 - 523 - 524S - 525 - 525S - 527 - 527S - 720S	To be used (and ordered) in conjunction with the receiver	Neutral pack
1126-9156-02	7313329620594	6	Bluetooth receiver	125 - 127 - 140 - 145 - 223 - 225S - 325 - 328S - 520 - 523 - 522 - 524S - 525 - 525S - 527 - 527S - 720S	For PC + Android and Apple OS smart phones	Neutral pack

# Wheels

Autoclip machines (both 2 and 4 WD) are built to mow grass effectively on flat and sloping landscapes. Stiga offer a wide range of accessory wheels to increase the already remarkable stability of their products. The machine is thus able to maintain its direction, maximizing the power efficiency of its battery. When equipped the machine has extra grip, climbing smoothly in all conditions, minimizing risk to the lawn.



**Packaging (pos. 3)**  
 DIMENSIONS: 27x27,5x0,5 cm  
 GROSS WEIGHT: 0,300 kg

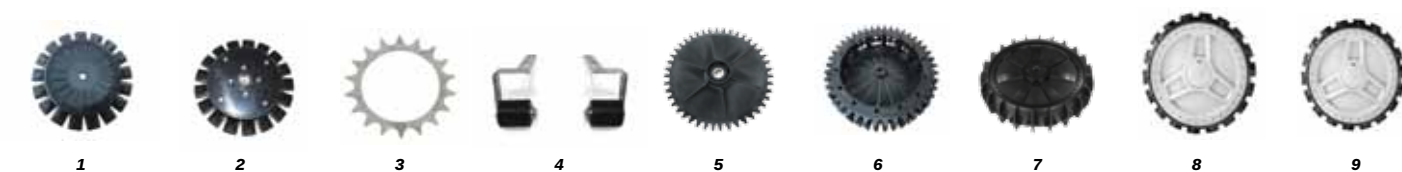

Code	EAN	Pos	Description	Fits for	NR pcs	Info	Note
1126-9130-01	7313329260356	1	Internal wheel teeth	140 - 145	1	To increase grip and for better cutting performances on the slopes. It has to be used in conjunction with item nr. 1126-9131-01.	Neutral pack
1126-9131-01	7313329260363	2	External wheel teeth	140 - 145	1	To increase grip and for better cutting performances on the slopes. It has to be used in conjunction with item nr. 1126-9130-01.	Neutral pack
1126-9151-01	7313329260554	3	Toothed (spike) wheel	223 - 225S - 520 - 522 - 523 - 524S - 525 - 525S - 527 - 527S	1	To increase grip and for better cutting performances on the slopes	Stiga pack
1126-9127-01	7313329260325	4	Anti tilt kit	520 - 523 - 525 - 525S	2	-	Neutral pack
1126-9116-01	7313329260219	5	Toothed wheel	720S	1	-	Neutral pack
1126-9129-01	7313329260349	6	Hooked wheel	720S	1	-	Neutral pack
1126-1428-01	7313329620617	7	Rubber wheel	125 - 127 - 325 - 328S	1	Ø 270 mm	Neutral pack
1126-9163-01	7313329620655	8	Stiga rubber wheel	125 - 127 - 325 - 328S	1	Ø 270 mm - Stiga logo	Neutral pack
1126-9168-01	7313329260615	9	Small stiga rubber wheel	223 - 225S - 522 - 524S	1	Ø 224 mm - Stiga logo	Neutral pack

# Blades

Stiga blades are made of robust steel, ensuring a long-lasting, very stable robot cutting performance; thanks to this grass will remain healthy after repeated mawing. Contrary to other manufacturers' technical solutions, Stiga's robustness and dimension give the robot extra solidity in case of impact with small objects (sticks or pebbles) allowing impact to occur without damage. More than just ensuring savings in financial outlay, this feature also adds to the safety of the product no dangerous metal-cutting shards and splinters will remain as debris on the lawn. Further, flat blades are designed with 8 sharpened cuttings, allowing for usage on both sides (inverting the wheels upside down). And their circular, flat shape, makes for easier sharpening.

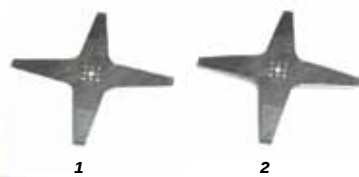

**Packaging**  
 DIMENSIONS: 21,5x21,5x0,5 cm  
 GROSS WEIGHT: 0,180 kg

**Packaging**  
 DIMENSIONS: 27x27,5x0,5 cm  
 GROSS WEIGHT: 0,300 kg

Code	EAN	Pos	Ø cm	Teeth	Cutting Edge	Shape	Fits for	Info	Note
1126-9143-01	7313329260479	1	25	4	8	Flat	125 - 127 - 223 - 225S	Screws are included	Stiga pack
1126-9144-01	7313329260486	2	25	4	4	Bent	140 - 145	Screws are included	Stiga pack
1126-9145-01	7313329260493	3	29	4	8	Flat	325 - 328S - 520 - 522 - 523 - 524S - 525 - 525S - 527 - 527S	Screws are included	Stiga pack
1126-9146-01	7313329260509	4	35	4	8	Flat	720S	Screws are included	Stiga pack



# Lithium Batteries & Chargers

Stiga guarantees original high quality accessories such as lithium batteries. This type of battery lasts 2-3 times longer than rechargeable batteries (Ni-Cd and Ni-Mh). It's light and doesn't suffer from the so-called "memory effect", has slow self-discharge if not used (about 5% per month) and discharges very slowly.



- 1**  
**Packaging**  
DIMENSIONS:  
10,2x19,5x7,2 cm  
GROSS WEIGHT:  
0,530 kg approx.
- 2**  
**Packaging**  
DIMENSIONS:  
10,2x19,5x7,2 cm  
GROSS WEIGHT:  
1,250 kg approx.
- 3**  
**Packaging**  
DIMENSIONS:  
32x18x4,8 cm  
GROSS WEIGHT:  
2,638 kg approx.
- 4**  
**Packaging**  
DIMENSIONS:  
32x18x4,8 cm  
GROSS WEIGHT:  
1,000 kg approx.
- 5**  
**Packaging**  
DIMENSIONS:  
32x18x4,8 cm  
GROSS WEIGHT:  
1,348 kg approx.



Code	EAN	Pos	Description	Specification	Fits for	Note
1126-9137-01	7313329260417	1	Lithium battery	25.2 V - 2.5 Ah	125 - 127 - 145 - 223 - 225S	Stiga pack
1126-9138-01	7313329260424	2	Lithium battery	25.2 V - 7.5 Ah	140 - 325 - 328S - 520 - 522 - 523 - 524 - 524S (2 pcs for 3500 mt <sup>2</sup> ) - 525 - 525S - 527 - 527S - 720S (2015 — 2 pcs for 6000 mt <sup>2</sup> )	Stiga pack
1126-9139-01	7313329260431	3	Lithium battery	25.2 V - 13.8 Ah	720S (— 2014)	Stiga pack
1126-9165-01	7313329620662	3	Lithium battery	25.2 V - 15.0 Ah	720S	Stiga pack
1126-9166-01	7313329620679	4	Battery charger	29.3 V - 2.3 Ah	1126-9137-01	Stiga pack
1126-9140-01	7313329260448	5	Battery charger	29.3 V - 5 Ah	1126-9138-01	Stiga pack
1126-9113-01	7313329260189	-	Battery charger	29.3 V - 12 Ah	720 S (for 6000 mt <sup>2</sup> )	Neutral pack

# Installation

To ensure best performance Autoclip robot models requiring installation should be subject to a careful installation procedure. To this end Stiga provides the best installation materials and solution. Autoclip **cable** is engineered to support an extremely strong sinusoidal signal - the strongest in the market for this product category. The cable ensures that the signal is strong at all points of the activity perimeter, even at elevated distances from the charging station. The cable is made in tin-plated copper and its diameter is - Ø 3.0 mm. (internal it's 1,5 mm.); reel length is 100 and 300 mt. The cable for the 223 and 225 S has a 2.35 mm outside diameter and 0.75mm inside diameter. During normal installation, if a joint on the cable is needed, Stiga offer a very good self bonding electrical tape. The **tape** is uniquely engineered and highly robust, water/humidity-proof, to join seamlessly into a single cable-tape. To optimise the effect, the tape has got to be stretched with fingers, before applying. **Nails** are provided in a 100 and 200 units pack.



- 1**  
**Packaging**  
DIMENSIONS:  
21,8x21,5x7,4 cm  
GROSS WEIGHT:  
2,060 kg
- 2**  
**Packaging**  
DIMENSIONS:  
21,8x21,5x7,4 cm  
GROSS WEIGHT:  
1,340 kg
- 3**
- 4**  
**Packaging**  
DIMENSIONS:  
25,2x19x9 cm  
GROSS WEIGHT:  
0,670 kg
- 5**
- 6**  
**Packaging**  
DIMENSIONS:  
11x13,8x2,8 cm  
GROSS WEIGHT:  
0,190 kg



Code	EAN	Pos	Description	Specification	Lenght	Fits for	Note
1126-9147-01	7313329260516	1	Cable	1x1.5 - Ø 3.0 mm	100 Mt	All	Stiga pack
1126-9167-01	7313329620679	2	Cable	1x0,75 - Ø 2.35 mm	100 Mt	223 - 225 S	Stiga pack
1126-9108-01	7313329260134	3	Cable	1x1.5 - Ø 3.0 mm	300 Mt	All	Neutral pack
1126-9149-01	7313329260530	4	Nails	Pieces: 100	-	All	Stiga pack
1126-9106-01	7313329260110	5	Nails	Pieces: 200	-	All	Neutral pack
1126-9148-01	7313329260523	6	Tape	For perimetral cable joints	-	All	Stiga pack

# Chain Saws



# Chains

## New Stiga Pack 2015



**Packaging**  
DIMENSIONS:  
8x16,5x2,5 cm  
GROSS WEIGHT:  
0,500 kg approx.



Code	EAN	Lenght	Pitch	Width	Type	Fits for	Note
1519-9110-01	7313329151609	40E	3/8"	0.050" (1.3 mm)	91VG	SPR 270, SPR 255 (10"bar)	Stiga pack
1519-9111-01	7313329151616	44E	3/8"	0.050" (1.3 mm)	91VG	SPR 350	Stiga pack
1519-9112-01	7313329151623	45E	3/8"	0.050" (1.3 mm)	91VG	SPR 255 (12"bar)/SC 436 QA	Stiga pack
1519-9114-01	7313329151630	49E	3/8"	0.050" (1.3 mm)	91VG	SP 355 (14" bar), SE 180	Stiga pack
1519-9115-01	7313329151647	50E	3/8"	0.050" (1.3 mm)	91VG	SE 1.6, SE 180, SE 190, SP 340, SE 182, SE 192, SE 202, SP 382	Stiga pack
1519-9116-01	7313329151654	52E	3/8"	0.050" (1.3 mm)	91VG	SP 352/36 ; 1600 (14" bar), SE 180Q/1814/1814 Q, SC 48 AE, SP 352/36 ; 1600 (14" bar), SE 180Q/1814/1814 Q, SC 48 AE	Stiga pack
1519-9117-01	7313329151661	53E	3/8"	0.050" (1.3 mm)	91VG	SP 375/375Q	Stiga pack
1519-9118-01	7313329151678	54E	3/8"	0.050" (1.3 mm)	91VG	SP 355 (16" bar)	Stiga pack
1519-9119-01	7313329151685	55E	3/8"	0.050" (1.3 mm)	91VG	-	Stiga pack
1519-9120-01	7313329151692	56E	3/8"	0.050" (1.3 mm)	91VG	SE 1.8, SE 200Q, SE 202, SP 352, 1600, SP 382 (16" bar)	Stiga pack
1519-9121-01	7313329151708	57E	3/8"	0.050" (1.3 mm)	91VG	SP 338, Pro 1800 , SE 2016 Q / 2216 Q , SEV 2416 Q, SE 2516 Q	Stiga pack
1519-9122-01	7313329151715	56E	0.325"	0.050" (1.3 mm)	95VP	SP 370, SP 410, SP 440, SP 480	Stiga pack
1519-9123-01	7313329151722	64E	0.325"	0.050" (1.3 mm)	95VP	SP 410	Stiga pack
1519-9124-01	7313329151739	66E	0.325"	0.050" (1.3 mm)	95VP	SP 420, SP 440, SP 442, SP 462, SP 472, SP 480, SP 405 / 405Q	Stiga pack
1519-9154-01	7313329151791	72E	0.325"	0.050" (1.3 mm)	95VP	SP 442, SP 480, SP 482	Stiga pack
1519-9125-01	7313329151746	56E	0.325"	0.058" (1.5 mm)	21BP	SP 460, SP 462, SP 510, SP 522, SP 480, SP 482	Stiga pack
1519-9127-01	7313329151753	64E	0.325"	0.058" (1.5 mm)	21BP	SP 43, 46	Stiga pack
1519-9133-01	7313329151784	72E	0.325"	0.058" (1.5 mm)	21BP	SP 510, SP 522 , SP 46/52	Stiga pack
1519-9131-01	7313329151760	78E	0.325"	0.058" (1.5 mm)	21BP	-	Stiga pack
1519-9132-01	7313329151777	60E	1/4"	0.050" (1.3 mm)	25AP	SPR 270C, SPR 255 C	Stiga pack

## Files & Filing Kit

Files and file kit simplify maintaining and keeps the chain sharpened. The kit consists of a handle, a guide for correct angling and a round and a flat file.

## New Stiga Pack 2015



**Packaging**  
DIMENSIONS:  
6,5x30x0,5 cm  
GROSS WEIGHT:  
0,70 Kg

1



**Packaging**  
DIMENSIONS:  
12x34x3 cm  
GROSS WEIGHT:  
0,270 Kg

2



Code	EAN	Pos	Description	File diameter	Section	Pack of	Note
1519-9102-01	7313329151548	1	Files	5/32" (4,0 mm)	●	3	Stiga pack
1519-9103-01	7313329151555	1	Files	3/16" (4,8 mm)	●	3	Stiga pack
1519-9104-01	7313329151562	1	Files	7/32" (5,5 mm)	●	3	Stiga pack
1519-9105-01	7313329151579	2	Filing kit	5/32" (4,0 mm)	●	-	Stiga pack
1519-9106-01	7313329151586	2	Filing kit	3/16" (4,8 mm)	●	-	Stiga pack
1519-9107-01	7313329151593	2	Filing kit	7/32" (5,5 mm)	●	-	Stiga pack

A man wearing a dark jacket, dark pants, and safety gear (earmuffs and a clear face shield) is using a brush cutter in a field of tall, dry grass. The brush cutter has a yellow motor housing and a long silver shaft. The background shows a line of green trees under a clear blue sky. A semi-transparent white box is overlaid on the image, containing the title text.

# *Brush Cutters & Trimmers*

# Trimmer Heads

For hedgecutters and trimmers, Stiga offers different cutting systems (nylon line and metal blades). These accessories are suitable for all users and perfect for the last touches that make a garden tidy and impeccable at all time.

## New Stiga Pack 2015



**Packaging (pos. 22)**  
DIMENSIONS: 10x13x5,5 cm  
GROSS WEIGHT: 0,180 kg



**Packaging (pos. 17-23-27)**  
DIMENSIONS: 11x8,5x10,9 cm  
GROSS WEIGHT: 0,325 kg



**Packaging (pos. 10-18)**  
DIMENSIONS: 13,5x7,5x13,5 cm  
GROSS WEIGHT: 0,480 kg



Code	EAN	Pos	Description	Specification	Fits for	Note
1911-9127-01	7313329190998	1	Spool w. line	-	SGT 2220 A	Stiga pack
1911-9125-01	7313329190974	2	Spool w. line	-	SGT 350	Stiga pack
1911-9126-01	7313329190981	3	Spool w. line	-	SGT 600	Stiga pack
1911-9024-01	7313329190530	4	Spool w. line	-	ST 1200	Stiga pack
1911-9025-01	7313329190547	5	Spool w. line	-	ST 1200 (2002-)	Stiga pack
383820503/0	8008989343257	6	Spool w. line	-	ST 27J (2008-)	Neutral pack
1911-9027-01	7313329190554	7	Spool w. line	-	ST 350, ST 350J	Stiga pack
118801751/0	8008989355502	8	Trimmer head	M10-female, LH-thread	SB 1000J	Neutral pack
6980300	8008989312697	9	Trimmer head	M8-female, LH-thread	SB 22, TB 23, BJ 250	Neutral pack
1911-9199-01	7313329191742	10	Trimmer head	M10-female, LH-thread	SB 250 D, SB 320 D, SB 420 D, SBC 226 J, SBC 226 JD	Stiga pack
6981223	8008989315650	11	Trimmer head	M10X1.25 female-LH thread	SB 25J, SB 25D	Neutral pack
383820504/0	7313328002018	12	Trimmer head	M10-female, LH-thread	SB 27J, SB 27JD (2008-), SB 32, SB 32D (2008-)	Neutral pack
323155000/0	8008989364436	13	Trimmer head	M10-female, LH-thread	SB 27J, SB 29J, SB 425, SB 426, SB 425H, SB 425HD, BJ 325, BJ 325D	Neutral pack
123155009/0	7313328002049	14	Trimmer head	M10-female, LH-thread	SB: 26J, 34, 34D, 28 (2012-), 33, 44, 28J, 28JD, 33D, 44D	Neutral pack
3L4353240/1	8008984989344	15	Trimmer head	M8-male, LH-thread	SB: 28, 30, 43P, 52 PRO, 29, 35, 435H, 435 H, 435HD, 29S, 29 SD; BJ: 335, 335D, 345D	Neutral pack
3L4353000/1	8008989343653	16	Trimmer head	M8-male, LH-thread	SB: 35S, 35S DS, 43S, 43S DS, 43S FS, 44P, 51S, 51DS, 51FS, 435 HD	Neutral pack
1911-9195-01	7313329191704	17	Trimmer head	M10-female, LH-thread	SBC 48 AE	Stiga pack
1911-9142-01	7313329191186	18	Trimmer head	M10-female, LH-thread	SBC: 425 H, 425 HD, 435 H, 435 HD, 627 K, 627 KD, 635 K, 635 KD, 643 KD, 645 K, 645 KD, 645 KF, 653 K, 653 KD, 653 KF	Stiga pack
383820507/0	7313329191056	19	Trimmer head	M10 female, LH-thread	SBK 27, SBK 27D, SBK 35, SBK 35D, SBK 45	Stiga pack
383820508/0	7313329191063	20	Trimmer head	M8-male, LH-thread	SBK 45D, SBK 53D	Stiga pack
118801750/0	8008989400110	21	Trimmer head	M8-male, RH-thread	SGT 1000J	Neutral pack
1911-9136-01	7313329191124	22	Trimmer head	M5-female, RH-thread	SGT 436A	Stiga pack
1911-9141-01	7313329191179	23	Trimmer head	M8-male, LH-thread	SGT 627 K	Stiga pack
323155002/1	8008989364443	24	Trimmer head	M8-male, LH-thread	ST 1100	Neutral pack
6980120	8008984959026	25	Trimmer head	-	ST 210, TR 22 CX	Neutral pack
6981308	8008989316299	26	Trimmer head	M8-female, LH-thread	ST 225J	Neutral pack
1911-9197-01	7313329191728	27	Trimmer head	M8-female, RH-thread	ST 250 J, SGT 226 J	Stiga pack
123155008/1	8008989364085	28	Trimmer head	M8-female, RH-thread	ST 26J, ST 28J	Neutral pack
323155001/1	8008989341352	29	Trimmer head	M10-female, LH-thread	ST 290, ST 291, ST 425J, ST 425HJ, ST 29S	Neutral pack
1911-9021-01	7313329190417	30	Trimmer head	Pressed on motor shaft	ST 500	Stiga pack
6985095	8008989350309	31	Trimmer head	-	ST 750, ST 900J	Neutral pack

# Trimmer Lines

The lines are available with 3 cross-sections and each one is featured by a different colour: **round-yellow** (high-strength resistant line, resistant to breakage. Highly flexible, suitable for any temperature and ideal for soft thick grass). **Square-grey** (highly resistant line suitable for all types of grass, even the toughest). **Star-shaped-black** (unmatched cutting performance, grass is clean cut, ensuring no breakage or tearing; constant and uniform consumption).

## Round section

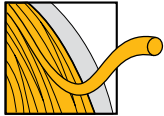

**Blister**  
DIMENSIONS:  
12x14x2,5 cm  
GROSS WEIGHT:  
0,150 kg approx



**Dispenser**  
DIMENSIONS:  
20x22x4 cm  
GROSS WEIGHT:  
0,500 kg approx



**Reel**  
DIMENSIONS:  
24,5x19x24,5 cm  
GROSS WEIGHT:  
3 kg approx

Code	EAN	Section	Diameter mm	Lenght mt	Type of pack	PCS per pack
1911-9149-01	7313329191254	●	1,6	15	Blister	75
1911-9150-01	7313329191261	●	2,0	15	Blister	75
1911-9151-01	7313329191278	●	2,4	15	Blister	50
1911-9152-01	7313329191285	●	2,7	15	Blister	50
1911-9153-01	7313329191292	●	3	15	Blister	50
1911-9154-01	7313329191308	●	3,5	12	Blister	50
1911-9155-01	7313329191315	●	4	15	1/2 dispenser	16
1911-9167-01	7313329191438	●	2	130	Dispenser	8
1911-9168-01	7313329191445	●	2,4	90	Dispenser	8
1911-9169-01	7313329191452	●	2,7	70	Dispenser	8
1911-9170-01	7313329191469	●	3	60	Dispenser	8
1911-9171-01	7313329191476	●	3,5	40	Dispenser	8
1911-9172-01	7313329191483	●	4	35	Dispenser	8
1911-9184-01	7313329191605	●	2,4	550	Reel	1
1911-9185-01	7313329191612	●	2,7	490	Reel	1
1911-9186-01	7313329191629	●	3	370	Reel	1

## Square section

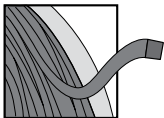

**Blister**  
DIMENSIONS:  
12x14x2,5 cm  
GROSS WEIGHT:  
0,150 kg approx



**Dispenser**  
DIMENSIONS:  
20x22x4 cm  
GROSS WEIGHT:  
0,500 kg approx



**Reel**  
DIMENSIONS:  
24,5x19x24,5 cm  
GROSS WEIGHT:  
3 kg approx

Code	EAN	Section	Diameter mm	Lenght mt	Type of pack	PCS per pack
1911-9156-01	7313329191322	■	2,0	15	Blister	75
1911-9157-01	7313329191339	■	2,4	15	Blister	50
1911-9158-01	7313329191346	■	2,7	15	Blister	50
1911-9159-01	7313329191353	■	3	15	Blister	50
1911-9160-01	7313329191360	■	3,5	12	Blister	50
1911-9161-01	7313329191377	■	4	15	1/2 dispenser	16
1911-9173-01	7313329191490	■	2	130	Dispenser	8
1911-9174-01	7313329191506	■	2,4	90	Dispenser	8
1911-9175-01	7313329191513	■	2,7	70	Dispenser	8
1911-9176-01	7313329191520	■	3	60	Dispenser	8
1911-9177-01	7313329191537	■	3,5	40	Dispenser	8
1911-9178-01	7313329191544	■	4	33	Dispenser	8
1911-9187-01	7313329191636	■	2,4	480	Reel	1
1911-9188-01	7313329191643	■	2,7	420	Reel	1
1911-9189-01	7313329191650	■	3	340	Reel	1

## Star section



**Blister**  
DIMENSIONS:  
12x14x2,5 cm  
GROSS WEIGHT:  
0,150 kg approx



**Dispenser**  
DIMENSIONS:  
20x22x4 cm  
GROSS WEIGHT:  
0,500 kg approx



**Reel**  
DIMENSIONS:  
24,5x19x24,5 cm  
GROSS WEIGHT:  
3 kg approx

Code	EAN	Section	Diameter mm	Diameter mm	Type of pack	PCS per pack
1911-9162-01	7313329191384	★	2	15	Blister	75
1911-9163-01	7313329191391	★	2,4	15	Blister	50
1911-9164-01	7313329191407	★	2,7	15	Blister	50
1911-9165-01	7313329191414	★	3	15	Blister	50
1911-9166-01	7313329191421	★	3,3	12	Blister	50
1911-9179-01	7313329191551	★	2	130	Dispenser	8
1911-9180-01	7313329191568	★	2,4	90	Dispenser	8
1911-9181-01	7313329191575	★	2,7	70	Dispenser	8
1911-9182-01	7313329191582	★	3	60	Dispenser	8
1911-9183-01	7313329191599	★	3,3	45	Dispenser	8
1911-9190-01	7313329191667	★	2,4	600	Reel	1
1911-9191-01	7313329191674	★	2,7	540	Reel	1
1911-9192-01	7313329191681	★	3	440	Reel	1

# Blades

Steel blades guarantee high performance and high resistance. The 1911-9134-01 blade has 24 teeth made of highly resistant steel. It complies with the ISO 7113 standard.

## New Stiga Pack 2015



### Packaging (pos. 2-4-7-9)

DIMENSIONS:  
27,8x27,8x0,5 cm  
GROSS WEIGHT:  
0,700 kg approx.



### Packaging (pos. 10)

DIMENSIONS:  
22,8x22,8x0,5 cm  
GROSS WEIGHT:  
0,600 kg



### Packaging (pos. 11)

DIMENSIONS:  
23x12,8x14 cm  
GROSS WEIGHT:  
0,340 kg

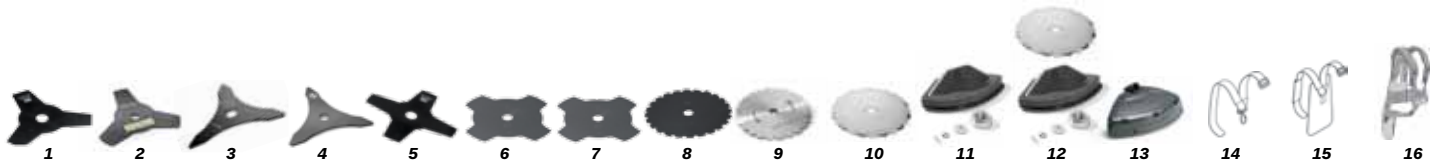

Code	EAN	Pos	Description	Specification (mm)	Fits for	Note
123155010/0	7313328002063	1	Blade (3T)	Ø = 255 hole = 25,4	B: 28, 28JD, 33, 33D, 44, 44D; BKE: 27, 27D, 35, 35D, 45, 45D, 53D, 53F; SBK: 27, 27D, 35, 35D, 45F, 53D, 53F; TB: 26, 26D, 26J, 26JD, 34, 34D; SB: 26, 26D, 26J, 26JD, 28, 28J, 28JD, 33, 33D, 34, 34D, 44, 44D	Neutral pack
123155005/0	8008989332534	1	Blade (3T)	Ø = 225 hole = 25,4	SB 27J, SB 27JD	Neutral pack
6031172	8008984989429	1	Blade (3T)	Ø = 230 hole = 25,4	SB: 29, 29S, 29DS, 35, 425, 425H, 425HD; BJ: 325, 325D	Neutral pack
118801752/0	8008989355519	1	Blade (3T)	Ø = 200 hole = 25,4	SB 1000 J	Neutral pack
1911-9198-01	7313329191735	2	Blade (3T)	Ø = 230 hole = 25,4	SB 250 D, SB 320 D, SB 420 D, SBC 226 J, SBC 226 JD	Stiga Pack
1911-9146-01	7313329191223	2	Blade (3T)	Ø = 255 hole = 25,4	SBC: 643KD, 645K, 654KD, 645KF, 653K, 653KD, 653KF	Stiga Pack
118802009/0	8008989357971	3	Blade (3T Arc)	Ø = 255 hole = 25,4	SBK 45D, SBK 53D	Stiga Pack
1911-9148-01	7313329191247	4	Blade (3T Arc)	Ø = 255 hole = 25,4	SBC: 627K, 627KD, 635K, 635KD, 643KD, 425H, 425HD, 435H, 435HD	Stiga Pack
6985037	8008989704300	5	Blade (4T)	Ø = 225 hole = 25,4	ESB 1000 J	Neutral pack
4611880	8008984989412	5	Blade (4T)	Ø = 255 hole = 25,4	SB: 29, 35, 35S, 35DS, 43, 43DS, 51, 51DS, 425, 435, 435H, 435HD; BJ: 335, 335D, 345D, SBK: 27, 27D, 35, 35D, 45D, 45F, 53D, 53F	Neutral pack
123155006/0	8008989332541	6	Blade (4T)	Ø = 255 hole = 25,4	SB 32, SB 32D	Neutral pack
1911-9196-01	7313329191711	2	Blade (4T)	Ø = 230 hole = 25,4	SBC 48 AE	Stiga Pack
1911-9147-01	7313329191230	7	Blade (4T)	Ø = 255 hole = 25,4	SBC: 627K, 627KD, 635K, 635KD, 643KD, 645K, 645KD, 645KF, 653K, 653KD, 653KF, 425H, 425HD, 435H, 435HD	Stiga Pack
6031185	8008989311935	8	Saw blade (24T)	Ø = 255 hole = 25,4	SB43/43DS/44/51/51DS	Neutral pack
1911-9139-01	7313329191155	9	Saw blade (24T)	Ø = 225 hole = 25,4	SBC 645 KD, SBC 653 KD	Stiga Pack
1911-9134-01	7313329191070	10	Saw blade (24T) HIGH QUALITY	Ø = 225 hole = 25,4	SBK 45D, SBK 53D, SBC 645KD, SBC 653KD	Stiga Pack
1911-9140-01	7313329191162	11	Saw blade guard		For blade 1911-9139-01	Stiga Pack
1911-9143-01	7313329191193	12	Kit saw blade (24T) + guard	Ø = 225 hole = 25,4	SBC 645 KD, SBC 653 KD	Stiga Pack
1911-9135-01	7313329191117	12	Kit saw blade (24T) + guard HIGH QUALITY	Ø = 225 hole = 25,4	SBK 45D, SBK 53D	Stiga Pack
8563571	-	13	Universal guard	24-26 mm	-	Neutral pack
8563572	-	13	Universal guard	28 mm	-	Neutral pack
4253420	-	14	Strap	-	-	Neutral pack
4253460	-	15	Strap	-	-	Neutral pack
123046002/0	-	16	Shoulder Strap	-	-	Neutral pack

# Batteries & Chargers

## New Stiga Pack 2015



1

**Packaging**  
DIMENSIONS: 10x18x7 cm  
GROSS WEIGHT: 1,224 kg approx.



2

**Packaging**  
DIMENSIONS: 13,8x21,1x8,3 cm  
GROSS WEIGHT: 0,625 kg approx.



3

Code	EAN	Pos	Description	Specification	Tech info	Fits for	Note
1911-9137-01	7313329191131	1	Lithium battery	36V 2,6Ah	-	SC 436 QA, SGT 436 A, SHT 436A	Stiga pack
1911-9138-01	7313329191148	2	Battery charger	42VDC 2A	CE plug	SC 436 QA, SGT 436 A, SHT 436A	Stiga pack
1911-9128-01	7313329191001	3	Lithium battery	20V 1,5Ah	-	SGT 2220 A, SHT 4620 A	Stiga pack
1911-9133-01	7313329191049	3	Lithium battery	24V 1,9Ah	-	SHT 5224 A	Stiga pack

# *Lawn Mowers*





# Blade Holders

Together with the blade, the blade holder is one of the main safety components both for tractors and walk behinds machinery. In case of clashes with obstacles, it's fundamental that both blade and blade holder remain complete, to avoid sharp parts hit the users or people around. For this reason, Stiga blade holders are tested with destructive and entirety tests to maintain complete safety.

New Stiga Pack  
2015



## Packaging (pos. 4)

DIMENSIONS: 12x53x3,7 cm  
GROSS WEIGHT: 1 Kg



Code	EAN	Pos	Description	Ø	Fits for	Contains	Note
322465602/1	8008989111948	1	Blade holder FAN	17	Collector 35-39EL, Turbo 39-41EL, Combi 40E		Neutral pack
1111-9120-01	7313329112341	2	Blade holder	22,2	Collector: 46S-46SB-53S-53SB-48SB, Razer: 46S-46PD-48S Multiclip: 50S-50SB-50S Blue-50SE-50S Plus-Plus 50SE-Euro, Turbo: 47S-48 SEB, 48 S BW Plus B-53S-53 S BW Plus B-48SB-48 SE4Q B, 53 SE 4 QB, Plus 50 SEV B Turbo Excel: 50S-50SE B-55S B (2010 →) 50SB-50 S4Q INOX B-55 SQ B/55 S4 QB, Turbo Power: 50 S B- 53 S B/, Multi mower, Combi 48S-48SEB-48SB-48 SQB-SQ BW-53 SQ-SEQ BW-53S-53 SQ BW-53SB-53 SQB,	122465607/3	Stiga pack
1111-9054-01	7313329110804	3	Blade holder	22,2	Collector, Multiclip	1111-1765-01	Stiga pack
1111-9250-01	7313329115298	4	Blade holder	-	Combi 36 AE (2015 →)	322465653/0	Stiga pack
322465644/1	8008989100133	1	Blade holder FAN	17	Combi 40 AE, Combi 44E, Combi 44AE		Neutral pack
1111-9066-01	7313329111481	5	Blade holder	22,2	Multiclip 46, Dino, Dino 47-47B	122465617/0	Stiga pack
322465622/0	8008989126669	6	Blade holder		Multiclip 46EL		Neutral pack
1111-9067-01	7313329111436	7	Blade holder	22,2	Multiclip: 46S-Pro 46-51S-Pro 51S, Tornado 51S	122465620/0	Stiga pack
1111-9023-02	7313329110231	8	Blade holder	22,2	Multiclip 48, Dino, Tornado	1111-0014-00	Stiga pack
1111-9168-01	7313329113386	9	Blade holder	22,2	Multiclip 50 (2009-)50 Plus-Euro, Turbo 47-48 Plus B (2011 →) - 48SH-53S4QH-47 Blue-47 S Blue-47-47 Q B-47 SQ B, Collector: 43-46-46B-48B-53, Combi 48 (2010 →), Combi 48 B, Multiclip 50 B-Euro 50 B-50 Blue-50B	122463012/2	Stiga pack
1111-9163-01	7313329113331	10	Blade holder	22,2	Multiclip: 50 Rental-Pro (2006 →)-50S Silent (2008 →)-50 S Rental (2010 →)-50 S-SE Rental B-Special B (2011 →)-Rental 50 B-Rental 50 S B-Rental 50 SE B	122465611/0	Stiga pack
122465612/1	8008989104780	10	Blade holder	25	Multiclip 50 Rental-Pro Honda (2008 →)-Pro 50 Svan (2010 →)-Pro 50 S Svan (2009 →)-Pro 4S Inox Svan (2009)-Pro 50 S4 INOX Svan- Pro 50- Pro 50 S, Multiclip Pro 50, Pro 50 S (2015 →)	-	Stiga pack
1111-9165-01	7313329113355	11	Blade holder	17	Multiclip 50 EL-50 el Svan (2010 →), Collector 46-48 el, Combi 48 el (2011 →), Combi 48 E-48ES	122463186/3	Stiga pack
1111-9179-01	7313329114475	9	Blade holder	25	Multiclip 50H (2008 →)-Euro 50 H-47 Q H, Turbo 48 Plus Honda (2011 →)	122463020/1	Neutral pack
1111-9119-01	7313329112334	12	Blade holder	22,2	Multiclip: 51S-53S-Pro 51S (→ 2009)	122465623/0	Stiga pack
122465632/0	8008989104865	13	Blade holder	25	Multiclip: 53S Honda (2008)-Pro 53 S-4S Svan (2010 →)-Pro 53 S Svan-Pro 53 S4 Svan	-	Stiga pack
1111-9126-01	7313329112549	13	Blade holder	22,2	Multiclip: Pro 46-48-51S-53S-Pro 51S Pro 53 S-Pro 53SB Rental-Rental 53 S B, Tornado Pro 51S	122465621/0	Stiga pack
1111-9127-01	7313329112556	14	Blade holder	22,2	Multiclip Pro 48, Turbo: Pro 48S-50S-50S B-55S-50S Rental (2010 →)-55S Rental (2011 →) 50 S Rental B-55 S Rental B	122465619/0	Stiga pack
1111-9023-01	7313329110224	15	Blade holder	22,2	Popular, Dino, Collector	1111-0107-00	Stiga pack
322465603/0	8008989126652	1	Blade holder FAN		Silent 33-41 el, Ladybird 33-41EL	-	Neutral pack
1111-9070-01	7313329111542	16	Blade holder	22,2	Turbo: 43-45-48-50-55, Multiclip Pro 48	122465618/0	Stiga pack
1111-9074-01	7313329111597	17	Blade holder	22,44	Turbo 45, Collector 45, Euro 45, Combi 45	381003381/0	Stiga pack
1111-9180-01	7313329114482	2	Blade holder	25	Turbo 48-53 S BW Plus Honda (2010 →)-48 S H-53SH, Turbo Power 53SH, Combi 46SH-48SQH-53SQH, Multiclip 50 SH	122465608/1	Stiga pack
122465636/0	8008989104872	18	Blade holder	22,2	Turbo 55 AVS, Turbo Pro 55 S4 B	-	Neutral pack
122465637/0	8008989104889	2	Blade holder	25	Turbo 55 AVS-Pro 55 4S (2011 →)	-	Neutral pack
1111-9181-01	7313329114499	16	Blade holder	25	Turbo 55S Honda (2008 →)	122465630/0	Stiga pack
1111-9182-01	7313329114505	20	Blade holder	22,2	Turbo Excel 50 AVS (2009)-Turbo 50SB	122465638/1	Stiga pack
1111-9183-01	7313329114512	20	Blade holder	25	Turbo Excel 50 AVS (2009 →)-50 S H AVS (2010 →)-55 S H AVS (2010 →)-55 S4Q H	122465639/1	Stiga pack
122465641/0	8008989104919	21	Blade holder	-	Turbo HD 60 MHV	-	Stiga pack
122465643/0	8008989104926	19	Blade holder	22,4	Turbo HD 60 MB	-	Neutral pack
25041	8008989101093	1	Blade holder FAN	-	Turbo HD 60 MB-60 MHV	-	Neutral pack
122465631/0	8008989104858	14	Blade holder	25	Turbo Pro 50S Honda (2008-), Turbo 50S Rental H-Pro 50S	-	Neutral pack

ATTENTION: for friction blade holders see the technical section

# Blades

A complete range of blades for different cutting procedure, always in total safety. All Stiga blades are tested and can be approved only if they stand the impact test to guarantee user's safety even in case of accidental clashes against stones, rocks or other hidden obstacles. Mulching blades mince grass into small particles, that remain under the bodywork, becoming soil for the lawn. The special drawing of the collecting blade has a fin on both tips to facilitate cut grass down flow, through the exhaust manifold, up to the grass catcher.

New Stiga Pack 2015



**Packaging (pos. 9)**  
 DIMENSIONS: 6,5x40x3,2 cm  
 GROSS WEIGHT: 0,3 Kg approx.



**Packaging (pos. 28)**  
 DIMENSIONS: 12x53x3,7 cm  
 GROSS WEIGHT: 1 Kg approx.

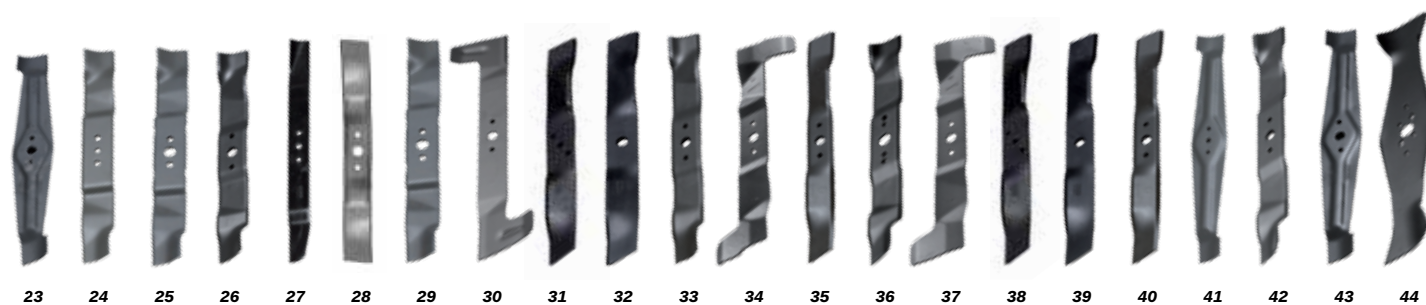
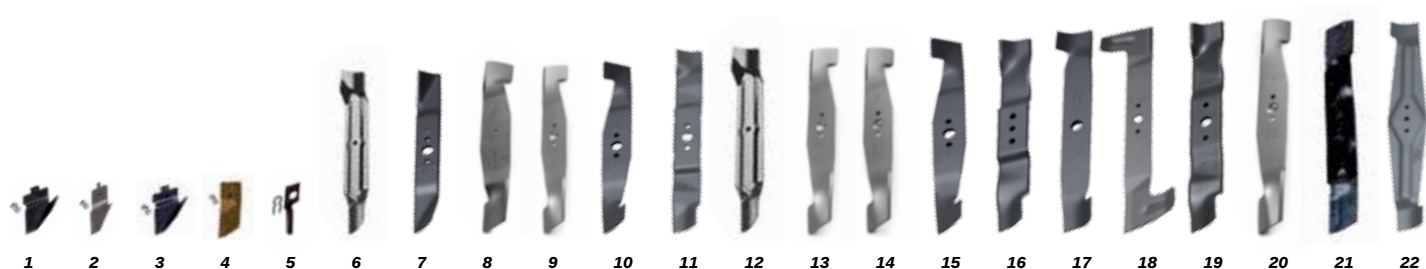



Code	EAN	Pos	Description	Lenght	Type	Fits for	Contains	Note
118810002/0	8008989121404	6	Blade	320	winged	Collector 34 E	-	Neutral pack
118810003/0	8008989121411	12	Blade	374	winged	Collector 40 E	-	Neutral pack
1111-9142-01	7313329113034	19	Blade	410	mulching	Collector 43	181004341/3	Stiga pack
1111-9194-01	7313329114628	30	Blade	456	winged	Collector 53S BW, Turbo: 53S BW-53 S4Q H-S Inox , Turbo 53 SEV QB Combi: 53 S-53SB	181004398/0	Stiga pack
181004157/0	8008989120773	8	Blade	340	winged	Collector: 36 E, 36 AE	-	Neutral pack
1111-9143-01	7313329113041	26	Blade	440	mulching	Collector: 44-46-46EL-46S-46B-46SB-46 S H, Combi: 46-46SH	181004365/3	Stiga pack
1111-9122-01	7313329112365	45	Blade	506	mulching	Collector: 53-53SB, Combi: 53-53S-53 SQ BW-53 SEQ BW (2010-)-53 SQH-53 SQB, Turbo: 53S BW Plus B-H (2009-)-53 S BW Plus B-53 S H, Turbo Power: 53SB-53SH	181004381/1	Stiga pack
1111-9248-01	7313329115274	9	Blade	340	winged	Combi 36 AE (2015-)	181004159/0	Stiga pack
181004156/0	8008989120766	13	Blade	380	winged	Combi 40 AE	-	Neutral pack
181004154/0	8008989100096	14	Blade	380	winged	Combi 40 E	-	Neutral pack
181004155/0	8008989100102	20	Blade	420	winged	Combi 44 E	-	Neutral pack
1111-9116-01	7313329112228	24	Blade	438	standard	Combi 45, Collector: 45-46, Silent 45, Turbo 45, Euro 45	181004121/0	Stiga pack
181004458/0	8008989120780	29	Blade	455	mulching	Combi: 48 SQ BW-48 SQ B-48 SQ H, Turbo: 48 SB-48 SH	-	Neutral pack
181004459/0	8008989100065	46	Blade	506	mulching	Combi: 53S-53SB	-	Neutral pack
1111-9502-01	7313329110064	27	Blade	450	standard	Dino, Dino 47, Dino 47B	181004124/1	Stiga pack
1111-9082-01	7313329111085	56	Blade	530	winged mulching	Euro 33 el, Silent 33 el, Ladybird 33 el	181004127/0	Stiga pack
1111-9115-01	7313329112211	16	Blade	393	standard	Euro 40, Collector 40	181004122/0	Stiga pack
1111-9079-01	7313329111412	21	Blade	430	mulching	Multiclip 46 el	1111-3010-01	Stiga pack
1111-9075-01	7313329111672	38	Blade	478	mulching	Multiclip 48-Pro 48	1111-2442-01	Stiga pack
1111-9184-01	7313329114529	35	Blade	467	mulching	Multiclip 50S, Silent	181004148/0	Stiga pack
1111-9076-01	7313329111689	49	Blade	508	mulching	Multiclip 51S, Pro 51S (holes 8 mm)	1111-2442-02	Stiga pack
1111-9133-01	7313329112617	32	Blade	458	mulching	Multiclip Pro 46	181004130/0	Stiga pack
1111-9049-01	7313329110514	4	Blade tips kit	-	mulching	Multiclip Pro 48	-	Stiga pack
1111-9078-01	7313329111450	31	Blade	458	mulching	Multiclip: 46-46 S-46 SE	1111-3099-01	Stiga pack
1111-9249-01	7313329115281	28	Blade	451	winged	Multiclip: 47 Blue-47 S Blue-47-47 Q B-47 SQ B-47 Q H	181004158/0	Stiga pack
1111-9131-01	7313329112594	39	Blade	478	mulching	Multiclip: 48 Rental-Pro 48	181004137/0	Stiga pack
1111-9155-01	7313329113232	40	Blade	478	mulching	Multiclip: 50-50 El Svan-50S-50 Plus-Pro 50-50 Rental-50S Rental-Pro 50 Svan (2009-)-Pro 50 4S (2011-)-50B-50SB-E Svan-50 Blue-50S Blue-50SE-50H-Rental 50 B-50SB-50SEB-Pro 50S Svan-Plus 50S-Euro 50B-Euro 50H-Plus 50-Plus 50SE-Plus 50SB-Plus 50SEB, 50 SH, Plus 50 SEV B	181004146/0	Stiga pack
1111-9109-01	7313329112143	48	Blade	508	mulching	Multiclip: 51S-53S, Pro 51S (holes 11 mm)	181004138/0	Stiga pack
1111-9132-01	7313329112600	50	Blade	508	mulching	Multiclip: 51S-53S-53S Rental, Pro 51S, Pro 53S Svan (2009-), Pro 53 4S Svan (2011-), Pro 53 SB, Rental 53 S B	181004139/0	Stiga pack
1111-9077-01	7313329111696	59	Blade bar	-	mulching	Multiclip: S-SE	1111-1603-01	Stiga pack
1111-9084-01	7313329111610	17	Blade	403	winged	Silent 41 el (plastic-chassis), Ladybird 42 el	181004119/0	Stiga pack
1111-9117-01	7313329112235	25	Blade	438	mulching	Silent 45 el, Ladybird 45	181004120/0	Stiga pack
1111-9094-01	7313329111078	51	Blade	510	standard	Tornado	1111-2598-01	Stiga pack
1111-9024-01	7313329110248	60	Blade disc	-	-	Tornado	-	Stiga pack
1111-9128-01	7313329112563	52	Blade	510	standard	Tornado Pro 51 S	1111-2598-02	Stiga pack
1111-9021-01	7313329110200	5	Blade tips kit	101	mulching	Tornado, Dino	-	Stiga pack
1111-9156-01	7313329113263	7	Blade	327	standard	Turbo 35 el, Collector 35 e-el	181004115/1	Stiga pack
1111-9046-01	7313329110453	2	Blade tips kit	98	mulching	Turbo 35 el, Silent 35 el	-	Stiga pack
1111-9157-01	7313329113270	10	Blade	367	winged	Turbo 39 el, Collector 39 el	181004142/0	Stiga pack
181004142/0	8008989120797	11	Blade	367	winged	Turbo 39 el, Collector: 39 e-el	-	Neutral pack
1111-9158-01	7313329113287	15	Blade	390	winged mulching	Turbo 41 el	181004145/0	Stiga pack
1111-9166-01	7313329113362	58	Blade	530	winged mulching	Turbo 45 S	181004132/0	Stiga pack
1111-9193-01	7313329114611	18	Blade	406	winged	Turbo 48 S-48B-48SEB-48SH-48 SE4Q B, Combi: 48S	181004397/0	Stiga pack
1111-9090-01	7313329111153	22	Blade	430	alettata mulching	Turbo 48-50, Collector 48-50	181004143/0	Stiga pack
1111-9129-01	7313329112570	23	Blade	430	winged mulching	Turbo 50 S Rental B-50 S Rental H-Pro 48S-50S-50S 50 S B Rental	181004135/0	Stiga pack
1111-9050-01	7313329110507	3	Blade tips kit	98	mulching	Turbo 510-530	-	Stiga pack
1111-9187-01	7313329114550	47	Blade	506	mulching	Turbo 53S Silent	181004394/0	Stiga pack
1111-9091-01	7313329111719	41	Blade	480	winged mulching	Turbo 55, Collector 55	181004144/0	Stiga pack
1111-9192-01	7313329114604	42	Blade	480	mulching	Turbo Excel 50 (2009), Turbo Power 50 S-B	181004366/2	Stiga pack
1111-9186-01	7313329114543	36	Blade	470	mulching	Turbo Excel 50 AVS-50 BBC	181004368/0	Stiga pack
1111-9189-01	7313329114574	34	Blade	466	mulching	Turbo Excel 50 S H AVS (2010-)	181004451/0	Stiga pack
1111-9190-01	7313329114581	54	Blade	525	mulching	Turbo Excel 55 S B (2010-)-Excel 55 SQ B	181004453/0	Stiga pack
1111-9191-01	7313329114598	53	Blade	514	mulching	Turbo Excel 55 S H AVS (2010-)-55 S4Q H	181004454/0	Stiga pack
181004455/0	8008989107378	55	Blade	525	winged	Turbo Excel 55 SH-55 SQ-B BBC	-	Neutral pack
1111-9188-01	7313329114567	37	Blade	477	winged mulching	Turbo Excel: 50 S B (2010-)-50 SE B (2010-)-50 S B/50 S4Q INOX B	181004450/0	Stiga pack
1111-9185-01	7313329114536	44	Blade	502	standard	Turbo HD 60 MB-60 MHV	181004149/0	Stiga pack
1111-9130-01	7313329112587	43	Blade	480	winged mulching	Turbo Pro 55S-Pro 55 4S-55S-Pro 55 S4 B Rental, Turbo 55 S Rental B	181004134/0	Stiga pack
1111-9048-01	7313329110460	1	Blade tips kit	86	mulching	Turbo: 42-460, Collector 46, Silent 42 el	-	Stiga pack
1111-9089-01	7313329111702	57	Blade	530	mulching	Turbo: 43-45	181004131/0	Stiga pack
1111-9121-01	7313329112358	33	Blade	460	mulching	Turbo: 47-48 S BW Plus (2010-)-48 Plus (2011-), Razer: 46S-46PD-48S, Collector: 46 Roller-48, 48 B-48 SB, Multimower 48, Combi 48 (2011-)-48E-48ES-48S-48B-48SB	181004346/3	Stiga pack

1111-9077-01 and 1111-9187-01 have 2 extra holes (Ø 6,5 mm) for fastening of the fan

# Belts

All Stiga belts are developed following measurements and tolerances which let the belt itself to adapt perfectly to the machine. Made with a specific length, different for each machine, Stiga belts guarantees the correct operations of all the parts, avoiding any possibility of damage or breaking that can occur using non original belt.

**New Stiga Pack  
2015**

\*



Code	EAN	Type	Fits for	Contains	Note
1111-9199-01	7313329114673	Transmission	Club Garden 46S	135063900/0	Stiga pack
1111-9058-01	7313329111184	Transmission	Collector 46S	9585-0080-00	Stiga pack
1111-9198-01	7313329114666	Transmission	Collector: 46S-46SB-46SH	135063750/0	Stiga pack
1111-9124-01	7313329112389	Transmission	Collector 53S, Combi 53S-53 SQ BW-53 SEQ BW (2010-)-53SQ B-53SQ H, Turbo 53S-53S BW Plus (2010-)-53 S BW Plus B-53SH ; Multiclip 50S-50S Plus-50S Rental-50S Special B-50S H-Pro 50 S Svan, Multiclip 50 S B-Rental 50 SE B	135063902/0	Stiga pack
1111-9200-01	7313329114680	Transmission	Collector: 53S-53 SB, Combi 53S, Multiclip: 50-50SH-50S-50SE-Blue-50SB-Plus 50-Plus 50S-Plus 50SE-Plus 50SE B-Rental 50SB-Rental 50SEB-Pro 50S Svan	135064100/0	Stiga pack
1111-9114-01	7313329112198	Transmission	Combi 45S, Collector 45S, Turbo 45S, Silent 45S el	135064000/0	Stiga pack
135064196/0	8008989105923	Transmission	Combi: 53 S-53SB	-	No pack
135064385/0	8008989105985	Transmission	Excel 50 S4Q INOX B	-	No pack
135064386/0	8008989105992	Transmission	Excel 55 S4Q H	-	No pack
1111-9060-01	7313329111207	Transmission	Multiclip 46S	1151-0128-10	Stiga pack
1111-9062-01	7313329111313	Transmission	Multiclip 46S	1151-0128-12	Stiga pack
1111-9125-01	7313329112532	Transmission	Multiclip 46S	1151-0128-17	Stiga pack
1111-9252-01	7313329115311	Transmission	Multiclip: 47 S Blue, 47 SQ B	135063802/0	Stiga pack *
1111-9113-01	7313329112181	Transmission	Multiclip 51S-53S-Pro 51S	1151-0128-16	Stiga pack
1111-9104-01	7313329111818	Transmission	Multiclip Pro 51S	1151-0128-15	Stiga pack
1111-9063-01	7313329111320	Transmission	Tornado 51S-Pro 51S	1151-0128-13	Stiga pack
1111-9059-01	7313329111191	Transmission	Tornado 90S	1151-0128-09	Stiga pack
1111-9053-01	7313329110743	Transmission	Turbo: 43-45, Tornado	135063173/0	Stiga pack
1111-9202-01	7313329114703	Transmission	Turbo 43S (4-speed)	135064373/0	Stiga pack
1111-9123-01	7313329112372	Transmission	Turbo: 47S-48SB-48SH-48SEB-48S-48 S BW Plus B-H, Collector: 43S-46S-48S-48SB-46S Roller, Combi: 48 ES-48S-48 SQ BW-48 SQ BW B-48SB-48SQB-48 SQH-53SB, Razer: 46S-46PD- 48S,	135063800/0	Stiga pack
1111-9061-01	7313329111306	Transmission	Turbo: 48S-50S, Turbo: 50S Rental-Pro 50 S-50 S B, Collector 48S	135063175/0	Stiga pack
1111-9065-01	7313329111344	Transmission	Turbo 48S (4-speed)	9585-0086-00	Stiga pack
1111-9203-01	7313329114710	Transmission	Turbo 48S (4-speed)	135064378/0	Stiga pack
1111-9251-01	7313329115304	Transmission	Turbo 48 SE4Q B	135064005/0	Stiga pack *
1111-9164-01	7313329113348	Transmission	Turbo 53S 4S-53 S4Q H, 53 S4Q B Multiclip: 50 4S-Pro 50 4S Inox Svan-53 S4-53S-53S Rental-Pro 53 S Svan-Pro 53 S B, Multiclip Plus 50 SEV B	135064010/0	Stiga pack
1111-9167-01	7313329113379	Transmission	Turbo: 55S-55 S Rental B (2011-)-Pro 55 4S (2011-)-Pro 55 S4 B, Collector 55S, Multiclip: 53S 4S-Pro 53 4S Svan	135064383/0	Stiga pack
1111-9064-01	7313329111337	Transmission	Turbo 55S, Collector 55S	9585-0049-00	Stiga pack
1111-9056-01	7313329111160	Transmission	Turbo: 420S-420 el	1151-0128-07	Stiga pack
1111-9051-01	7313329110729	Transmission	Turbo 460S, Multiclip S	1151-0128-01	Stiga pack
1111-9052-01	7313329110736	Transmission	Turbo 510S, Multiclip Pro 511S	1151-0128-05	No pack
1111-9057-01	7313329111177	Transmission	Turbo 530S	9585-0074-00	Stiga pack
1111-9201-01	7313329114697	Transmission	Turbo: Excel 50-Power 50 SB	135064150/0	No pack
135064391/0	8008989106012	Transmission	Turbo Excel: 50 S-SE-S H AVS (2010-)-50 S B-50 SE B,-50 S B	-	Stiga pack
1111-9197-01	7313329114659	Transmission	Turbo Excel 50 variospeed	135064384/0	Stiga pack
135064392/0	8008989106029	Transmission	Turbo Excel: 55 S-S H AVS (2010-)-55 S B-55SQ B-55SQ B BBC	-	Stiga pack
1111-9196-01	7313329114642	Transmission	Turbo HD 60 MB	155007	Stiga pack
1111-9195-01	7313329114635	Transmission	Turbo HD 60 MHV	14586	Stiga pack
135064195/0	8008984140899	Transmission	Turbo: Power 53 S B-Power 53 S H	-	Stiga pack
135063175/0	8008989105862	Transmission	Turbo Pro 50SB-50S	-	No pack

## Lithium Batteries & Chargers

As to battery lawnmowers, apart from the batteries supplied with the machine (2.6 and 3.0 Ah) a more powerful battery is available (4.4 Ah) allowing mowing for longer periods of time. All Stiga batteries are lithium. The quick battery charger allows cutting down on recharging time. In fact, thanks to it, it is possible to recharge the battery in 1 hour rather than 3 hours as in traditional battery charger.



Code	EAN	Pos	Description	Specification	Tech info	Fits for	Note
1111-9222-01	7313329115014	1	Lithium battery	36V 4,4 Ah	-	Combi 36AE-40AE (— 2014)	Stiga pack
1111-9224-01	7313329115021	1	Lithium battery	36V 3,0 Ah	-	Combi 36AE-40AE (— 2014)	Stiga pack
1111-9221-01	7313329115007	1	Lithium battery	36V 2,6 Ah	-	Combi 40 AE (— 2014)	Stiga pack
118204132/1	8008989102380	2	Charger	1 A	CE plug	Combi 36AE-40AE (— 2014)	Neutral pack
1111-9223-01	7313329114932	2	Fast charger	3 A	CE plug	Combi 36AE-40AE (— 2014)	Stiga pack
118204133/1	8008989102397	3	Charger	1 A	UK plug	Combi 36AE-40AE (— 2014)	Neutral pack

## Starter Batteries & Chargers



Code	EAN	Pos	Description	Specification	Tech info	Fits for	Note
118120052/0	8008984976627	1	Battery	12V, 4 Ah	-	Combi: 48SE-53SE BW (2009—)-53SEQ BW (2011—), Turbo 45 S Rental (2009—)-48SE BW (2009-)-48SEB-50SE-SE Pro-50 Rental-Excel 50 SE-53 SE BW-55SE-55SE Rental-Pro 55; Multiclip: 50SE-50SE Rental-Pro 50 Svan-53 SE-53SE Rental-Pro 53 Svan-53 Plus-Plus 50SE-Rental 50 SEB, Collector: 53 SE BW (2008—)-SE 53 (2007—)	Neutral pack
118120053/0	8008989102342	2	Battery	12V, 4,5 Ah	-	Collector 46S-53SE (2008—), Combi 46S-53S (2009—)	Neutral pack
118204120/0	8008989121039	3	Charger		CE plug	118120052/0, 118120053/0	Neutral pack
118204121/0	8008989102373	3	Charger		UK plug	118120052/0, 118120053/0	Neutral pack

## Care

The Stiga scraper is ideal to get rid of the grass and soil residues left on the cutting tray quickly and safely, since it guarantees super performance over time. As for lawnmowers already fitted with a hose attachment, we recommend residues are removed with the scraper before using the water jet. Thanks to the protective cover in strong waterproof nylon and available in two sizes, when not in use the machine can be left away from dust, dirt and the weather.

New Stiga Pack 2015



1

**Packaging**  
DIMENSIONS:  
28x21x9 cm  
GROSS WEIGHT:  
0,565 kg (small)  
0,680 kg (large)



2

**Packaging**  
DIMENSIONS:  
11,5x3,5x11 cm  
GROSS WEIGHT:  
0,150 kg

Code	EAN	Pos	Description	Features	Measures cm	Note
1111-9225-01	7313329115045	1	Small protective cover for WBH	Grey Stiga logo	145 x 50 x 110	Stiga pack
1111-9226-01	7313329115052	1	Large protective cover for WBH	Grey Stiga logo	180 x 60 x 115	Stiga pack
1111-9227-01	7313329115069	2	Scraper	-	Scraper	Stiga pack

A man with a beard, wearing a light blue checkered shirt and dark pants, is smiling while operating a yellow and grey front loader. The machine is positioned on a grassy area next to a large tree with a mossy trunk. The background is filled with lush green trees and foliage. A semi-transparent white banner is overlaid across the middle of the image, containing the text 'Front Mowers'.

# *Front Mowers*

# Blades

New Stiga Pack  
2015



## Packaging (pos. 24-26)

DIMENSIONS: 12x53x3,7 cm  
GROSS WEIGHT: 1 Kg approx.

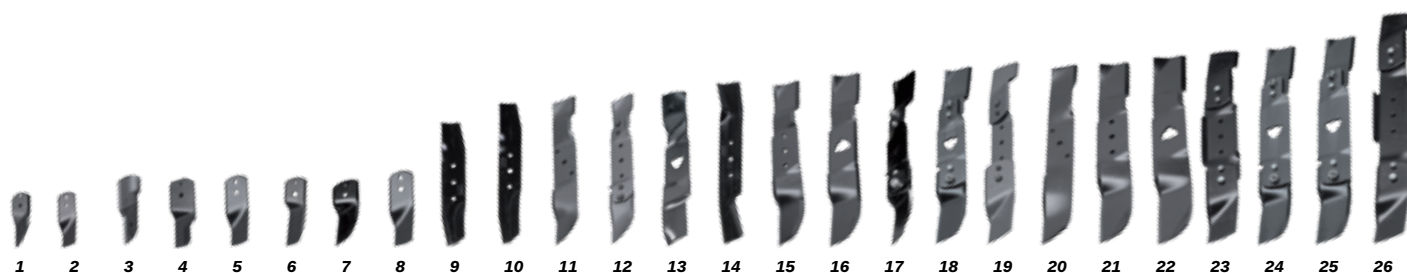

Code	EAN	Pos	Description	Tech info	Type	Fits for	Year	Packaging	Use with Nuts&Bolts	Note
1137-0989-01	8008989427513	23	Blade bar	Ø 475 mm	Mulching	90 Combi	2013 —	Package of 1	Type B	Neutral pack
1134-9158-01	7313329131953	13	Blade	392 (Ø 396) mm	Mulching	Park 100 Combi 3	2011 —	Package of 3	None	Stiga pack
1134-9001-01	7313329110750	10	Blade	368 mm	Standard	Park 100B	-	Package of 3	None	Stiga pack
1134-9052-01	7313329130383	12	Blade bar	380 mm	Mulching	Park 102M, Villa 102M	1998 - 2002	Package of 3 (short bar)	None	Stiga pack
1134-9053-01	7313329132097	1	Blade tips	Ø 8,1 mm	Mulching	1134-9052-01	1998 - 2002	Package of 2. Mounted underneath the blade bar	Type A	Stiga pack
1134-9118-01	7313329131205	25	Blade bar	545 mm	Mulching	Park 105 Combi	2007-	Package of 2	Type B	Stiga pack
1134-9107-01	7313329131090	15	Blade	421 (Ø 425) mm	Mulching	Park 110 Combi (2006)	2006	Package of 3-3 mounting holes	None	Stiga pack
1134-9124-01	7313329131281	16	Blade	421 (Ø 425) mm	Mulching	Park 110 Combi (2007-), Park 110 C Pro EL	2007 —	Package of 3 1 central mounting hole	None	Stiga pack
1134-2547-01	8008989403784	14	Blade	408 mm	Standard	Park 110S	-	Side discharge	None	Neutral pack
1134-9039-01	7313329111252	20	Blade	450 mm	Mulching	Park 121M	— 1997	Package of 3	None	Stiga pack
1134-9081-01	7313329130819	19	Blade bar	448 mm	Mulching	Park 121M	2003 - 2007	Package of 3	Type A	Stiga pack
1134-9086-01	7313329130918	21	Blade	456 (Ø 460) mm	Mulching	Park 125 Combi (2004-2006)	2004 -2006	Package of 3 3 mounting holes	None	Stiga pack
1134-9125-01	7313329131298	22	Blade	456 (Ø 460) mm	Mulching	Park 125 Combi (2007-), Park 125 C Pro EL	2007 —	Package of 3 1 central mounting hole	None	Stiga pack
1134-9063-01	7313329130598	3	Blade tips (cw)	Ø 11,2 mm	Mulching	Park 92M, Park 107M	2001	Package of 3	Type A	Stiga pack
1134-9063-02	7313329130604	4	Blade tips (ccw)	Ø 11,2 mm	Mulching	Park 92M, Park 107M	2001	Package of 3	Type A	Stiga pack
1134-9129-01	7313329131113	17	Blade bar	Ø 425 mm	Mulching	Primo, 78 Combi	2008-	Package of 2	Type B	Stiga pack
1134-9116-01	7313329131182	18	Blade bar	445 mm	Mulching	Ready 85 Combi, Villa 85 Combi	2007 —	Package of 2	Type B	Stiga pack
1134-9080-01	7313329130802	19	Blade bar	448 mm	Mulching	Ready 85M, Villa 85M	2003 - 2007	Package of 2	Type A	Stiga pack
1134-9082-01	7313329130826	2	Blade tips	Ø 8,1 mm	Mulching	1134-9080-01, 1134-9081-01	2003 - 2007	Package of 3. Tips mounted on top of the blade bar	Type A	Stiga pack
1134-9120-01	7313329131229	24	Blade bar	493 mm	Mulching	Ready 92M, Villa 92M, Park 92M	2002 - 2006	Package of 2 (cw + cw)*	Type B	Stiga pack
1134-9123-01	7313329131250	5	Blade tips (cw)	Ø 11,2 mm	Mulching	1134-9120-01, 1134-9121-01,	2002 - 2006	Package of 2 (cw)	Type B	Stiga pack
1134-9002-01	7313329110767	11	Blade	370 mm	Mulching	Villa 102M, Park 100M, 102M	— 1997	Package of 3	None	Stiga pack
1134-9121-01	7313329131236	26	Blade bar	580 mm	Mulching	Villa 107M, Park 107M	2002 - 2006	Package of 2 (cw + cw)*	Type B	Stiga pack
1134-9122-01	7313329131243	26	Blade bar	580 mm	Mulching	Villa 107M, Park 107M	2002 - 2006	Package of 2 (cw + ccw)*	Type B	Stiga pack
1134-9123-02	7313329131267	6	Blade tips (cww)	Ø 11,2 mm	Mulching	1134-9122-01 (together with 1134-9123-01)	2002 - 2006	Package of 2 (cww)	Type B	Stiga pack
1134-9003-01	7313329110774	9	Blade	310 mm	Standard	Villa 85B	-	Package of 3	None	Stiga pack
1134-9038-01	7313329111245	20	Blade	450 mm	Mulching	Villa 85M	— 1997	Package of 2	None	Stiga pack
1134-9117-01	7313329131199	23	Blade bar	495 mm	Mulching	Villa 95 Combi, Park 95 Combi	2007 —	Package of 2	Type B	Stiga pack
1134-9130-01	7313329131359	8	Blade tips	Ø 11,2 mm	Mulching	78 Combi - 90 Combi - Primo	2008 —	Package of 2. (Tips, shear bolts and nuts)	-	Stiga pack
1134-9119-01	7313329131212	7	Blade tip kit	Ø 11,2 mm	Mulching	All 85-95-105	2007 —	Package of 2. (Tips, shear bolts and nuts)	-	Stiga pack

\* Use thick fine threaded bolt \*\*cw=clockwise rotation \*\*\*counter clockwise rotation

# Blade Holders

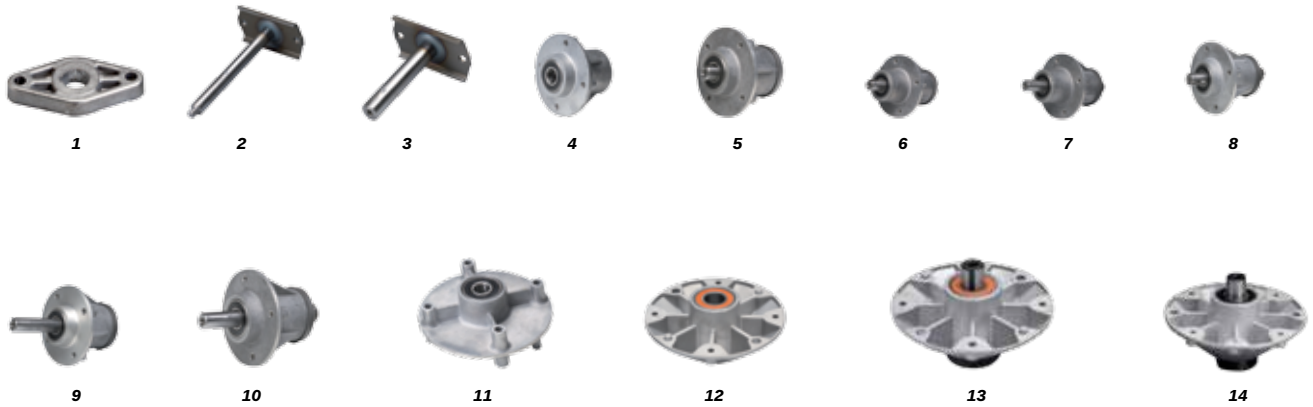

Code	EAN	Pos	Description	Tech info	Fits for	Year	Use with Nuts&Bolts	Use with Belt Pulleys	Note
1134-3841-01	8008989408192	4	Bearing box (w. bear.)	w/o shaft	Park 100B, 102M, 121M, Villa 85M, 102M	(1998 -2007)(1998 -2007)	Type E	-	Neutral pack
1134-4600-01	7313329132226	2	Blade shaft	L= 146 mm	Park 100B, 102M, 121M, Villa 85M, 102M	(2001-2007)	Type E	-	Neutral pack
1134-0430-01	8008989401698	6	Bearing box assy	Centre	Park 100B, 110S	(- 1998)	Type D	-	Neutral pack
1134-0428-01	8008989401674	5	Bearing box assy	Outer	Park 100B, 110S, Villa 85B	(1989- 1998)	Type D	-	Neutral pack
1134-5831-02	8008989418801	13	Bearing box-center	Shaft incl.	Park 100C, Park 110C Pro, Park 125C Pro	(2007-)	Type G	-	Neutral pack
1134-2477-01	8008989403623	7	Bearing box assy	Centre	Park 100M	(- 1995)	Type D	-	Neutral pack
1134-2476-01	8008989403616	8	Bearing box assy	Outer	Park 100M	(- 1995)	Type D	-	Neutral pack
1134-3696-01	8008989407461	10	Bearing box assy	Centre	Park 102M, 121M, Villa 85M, 102M	(1991- 1997)	Type D	-	Neutral pack
1134-3696-02	8008989407478	4	Bearing box assy	Outer	Park 102M, 121M, Villa 85M, 102M	(1991- 1997)	-	-	
1134-4600-02	8008989412069	2	Blade shaft	L= 168 mm	Park 102M, 121M, Villa 85M, 102M	(1998 -2007)(1998 -2007)	Type E	-	Neutral pack
1134-5126-01	8008989415008	3	Blade shaft	Ø = 20 mm	Park 107M HD	(2003-2006)	Type F	1134-5128-01 (see page 47)	Neutral pack
1134-5049-02	8008989414636	11	Bearing box (w. bearing)	w/o shaft	Park 107M HD	(2003-2006)	Type F	1134-5128-01 (see page 47)	Neutral pack
1134-5872-01	8008989423508	12	Bearing box (w. bearing)	w/o shaft	Park 110C Pro, 125C Pro	(2004-2006)	Type G	-	Neutral pack
1134-5401-02	8008989416982	2	Blade shaft-center		Park 110C Pro, 125C Pro	(2004-2006)	Type G	-	Neutral pack
1134-5401-01	8008989416975	2	Blade shaft-outer	Ø = 25 mm	Park 110C Pro, 125C Pro	(2004-2006)	Type G	-	Neutral pack
1134-5052-04	7313329132080	2	Blade shaft	L= 131.5 mm	Park 92M, 107M, Villa 92M, 107M, Ready	(2002-2006)	Type E	-	Neutral pack
1134-5049-01	8008989414629	11	Bearing box (w. bear.)	w/o shaft	Park 92M, 107M, Villa 92M, 107M, Ready	(2002-2006)	Type E	-	Neutral pack
1134-9000-01	7313329110712	1	Blade holder assy	Ø=20 mm	Park, Villa	(<- 2000)	Type C	-	Neutral pack Pack of 3
1134-6613-02	7313329132264	14	Bearing box assy	Shaft incl. Ø = 20 mm	Primo, Combi 78, Combi 90	(2008-)	Type I	1134-9137-01 (see page 47)	Neutral pack
1134-0428-02	8008989401681	9	Bearing box assy	Centre	Villa 85B	(- 1998)	Type D	-	Neutral pack
1134-5052-03	8008989414643	2	Blade shaft	L= 150.5 mm	Villa 92M, 107M, Ready	(2002-2006)	Type E	-	Neutral pack
1134-5831-01	7313329132240	13	Bearing box-outer	Shaft incl.	Villa/Park 85-95-105, Park 100C, Park 110C Pro, Park 125C Pro	(2007-)	Type G	-	Neutral pack



# Belts

## New Stiga Pack 2015



TYPE OF BELTS	A	B	C	D
DESCRIPTION	Engine - Gearbox/transaxle/hydrostatic unit	Engine - PTO	PTO - Mower deck	Mower deck

Code	EAN	Type	Mater.	Fits for	Contains	Note
1134-9018-01	7313329111122	A	Rubber	Garden 6, Garden 8, Park Senator	9585-0120-00	Stipa pack
1134-9035-01	7313329130215	A	Rubber	Park 10, 11, 12, Park Classic, Park Pro 16, Park Pro 18	9585-0078-00	Stipa pack
1134-9036-01	7313329130222	A	Rubber	Park 13 HST, President HST, Park Millenium	9585-0083-00	Stipa pack
1134-9008-01	7313329130048	A	Rubber	Park 2000, Villa I, Pony	9585-0050-00	Stipa pack
1134-9013-01	7313329130093	A	Rubber	Park 2002, Park 12 (not HST), Park Compact, Garden, Scoop	9585-0057-00	Stipa pack
1134-9029-01	7313329130154	A	Rubber	Park HST, Park Diesel, Park Pro 16, 18, 20, Park flail mower	9585-0055-00	Stipa pack
1134-9055-01	7313329130413	A	Rubber	Park President, Villa I President HST, Millenium	9585-0089-00	Stipa pack
1134-9058-01	7313329130475	A	Rubber	Park President, Park Power, Park Comfort, Park Royal, Park Excellent, Park Farmer, Park Compact HST, Park Jubilee, Park Pro 4WD, Park 320 M, Park Compact 16, Park Pro 540 IX, Park Pro 740 IOX, Park 540 DPX	9585-0091-01	Stiga pack
1134-9134-01	7313329131397	A	Kevlar	Primo	9585-0174-01	Stipa pack
1134-9168-01	8008989424116	A	Rubber	Villa 320, Villa 520, Villa 720	9585-0216-01	Stiga pack
1134-9164-01	7313329132011	A	Kevlar	Villa Master, Villa Senator, Villa Comfort, Ready, Villa Royal, Park 340 MX, Villa 13	9585-0209-01	Stipa pack
1134-9165-01	7313329132042	A	Rubber	Villa President, Villa Prestige, Villa Elegance, Villa Excellence, Ready HST		Stipa pack
1134-9047-01	7313329130338	B	Rubber	Park 18 HST, Park Pro 18-20, Park Pro Diesel	9585-0088-00	Stipa pack
1134-9019-01	7313329130130	B	Rubber	Park 2000	9585-0100-00	Stipa pack
1134-9012-01	7313329130086	B	Rubber	Park 2002, 10, 11, 12, 13, 16, Park Classic, Millenium, Park Senator, Park President, Park Pro 16, Park Royal	9585-0056-00	Stipa pack
1134-9014-01	7313329130253	B	Rubber	Park 2002 Diesel, Villa sweeper	9585-0058-00	Stipa pack
1134-9078-01	7313329130789	B	Rubber	Park Flail Mower	9585-0138-01	Stipa pack
1134-9097-01	7313329130994	B	Rubber	Park Prestige 4WD, Pro 4WD, Park Pro 540 IX, Park Pro 740 IOX	9585-0147-01	Stipa pack
1134-9098-01	7313329131007	B	Rubber	Park Prestige 4WD, Pro 4WD, Park Compact 4WD, Diesel, Park Pro 540 IX, Park Pro 740 IOX, Park Compact 16 4WD, Park 320 M, Park 340 MX	9585-0148-01	Stiga pack
1134-9071-01	7313329130680	B	Rubber	Park Senator, Park President, Park Royal, Park Pro 16, Park Comfort, Park Compact, Park Excellent, Park Farmer, Park Jubilee, Park 320 M, Park 340 MX	9585-0129-01	Stipa pack
1134-9135-01	7313329131403	B	Kevlar	Primo	9585-0188-01	Stipa pack
1134-9146-01	7313329131496	B	Kevlar	Ready, Villa, Villa 13, Villa 13 SHT	9585-0204-01	Stipa pack
1134-9066-01	7313329130635	B	Kevlar	Villa	9585-0125-01	Stipa pack
1134-9089-01	7313329130888	B	Kevlar	Villa I Classic, Park 2000	9585-0141-01	Stipa pack
1134-9172-01	8008989424147	B	Rubber	Villa 320, Villa 520, Villa 720	9585-0214-01	Stiga pack
1134-9167-01	8008989424109	B	Rubber	Villa 320, Villa 520, Villa 720	9585-0215-01	Stiga pack
1134-9079-01	7313329130796	B	Rubber	Villa Master, Villa President, Villa Comfort, Ready, Villa 13, Villa 13 SHT	9585-0139-01	Stipa pack
1134-9017-01	7313329130123	C	Rubber	Garden 6, 8	9585-0119-00	Stipa pack
1134-9033-01	7313329130192	C	Rubber	Garden 65B, Scoop	9585-0076-00	Stipa pack
1134-9032-01	7313329130185	C	Rubber	Garden 65S, Scoop	9585-0075-00	Stipa pack
1134-9048-01	7313329130345	C	Rubber	Garden 72S, 72M	9585-0122-00	Stipa pack
1134-9109-01	7313329131113	C	Kevlar	Park 92M (4WD), Villa 85C	9585-0160-01	Stipa pack
1134-9147-01	7313329131502	C	Kevlar	Park 95 Combi (4WD)	9585-0197-01	Stipa pack

## Belts

Code	EAN	Type	Mater.	Fits for	Contains	Note
1134-9148-01	7313329131519	C	Kevlar	Park 95 Combi (2WD)	9585-0198-01	Stipa pack
1134-9011-01	7313329130079	C	Rubber	Park 100 B	9585-0054-00	Stipa pack
1134-9156-01	7313329131939	C	Kevlar	Park 100 Combi 3 (2WD)	9585-0205-01	Stipa pack
1134-9157-01	7313329131946	C	Kevlar	Park 100 Combi 3 (4WD)	9585-0206-01	Stipa pack
1134-9015-01	7313329130109	C	Rubber	Park 100M	9585-0061-00	Stipa pack
1134-9045-01	7313329130314	C	Rubber	Park 102M, 107M, 121M	9585-0081-01	Stipa pack
1134-9150-01	7313329131533	C	Kevlar	Park 105 Combi (2WD)	9585-0200-01	Stipa pack
1134-9149-01	7313329131526	C	Kevlar	Park 105 Combi (4WD)	9585-0199-01	Stipa pack
1134-9067-01	7313329130642	C	Rubber	Park 107M (2WD)	9585-0126-01	Stipa pack
1134-9034-01	7313329130208	C	Rubber	Park 107M HD (2WD)	9585-0073-00	Stipa pack
1134-9101-01	7313329131038	C	Kevlar	Park 107M HD, sweeper (4WD)	9585-0155-01	Stipa pack
1134-9100-01	7313329131021	C	Kevlar	Park 107M (4WD)	9585-0158-01	Stipa pack
1134-9151-01	7313329131540	C	Kevlar	Park 110 Combi (2WD)	9585-0201-01	Stipa pack
1134-9108-01	7313329131106	C	Kevlar	Park 110 Combi (4WD)	9585-0159-01	Stipa pack
1134-9016-01	7313329130116	C	Rubber	Park 110S, 122B	9585-0066-00	Stipa pack
1134-9102-01	7313329131045	C	Kevlar	Park 121M (4WD), Villa 105C	9585-0157-01	Stipa pack
1134-9152-01	7313329131557	C	Kevlar	Park 125 Combi (2WD)	9585-0202-01	Stipa pack
1134-9103-01	7313329131052	C	Kevlar	Park 125 Combi (4WD)	9585-0156-01	Stipa pack
1134-9020-01	7313329130147	C	Rubber	Park 2000	9585-0103-00	Stipa pack
1134-9056-01	7313329131465	C	Rubber	Park flail mower	9585-0123-00	Stipa pack
1134-9096-01	7313329130666	C	Rubber	Park flail mower (4WD)	9585-0149-01	Stipa pack
1134-9044-01	7313329130307	C	Rubber	Park snow thrower	9585-0079-01	Stipa pack
1134-9041-01	7313329130277	C	Rubber	Park sweeper (2WD)	9585-0067-01	Stipa pack
9585-0211-01	8008989446873	C	Kevlar	Park sweeper (2 WD)	-	No pack
9585-0210-01	8008989446866	C	Kevlar	Park sweeper (4 WD)	-	No pack
1134-9043-01	7313329130291	C	Rubber	Park coll. sweeper (2WD)	9585-0070-01	Stipa pack
1134-9049-01	7313329130352	C	Rubber	Pony 8, 10	9585-0109-00	Stipa pack
1134-9136-01	7313329131410	C	Kevlar	Primo	9585-0176-01	Stipa pack
1134-9009-01	7313329130055	C	Rubber	Villa I 85B	9585-0052-00	Stipa pack
1134-9031-01	7313329130178	C	Rubber	Villa I 85M, 102M, coll.sweeper	9585-0072-00	Stipa pack
1134-9068-01	7313329130659	C	Rubber	Villa II 107M, Villa 95C	9585-0127-01	Stipa pack
1134-9069-01	7313329130666	C	Rubber	Villa 92M, Ready 92M	9585-0128-01	Stipa pack
1134-9076-01	7313329130765	C	Rubber	Villa 85M, Ready 85M	9585-0134-01	Stipa pack
1134-9169-01	7313329132271	C	Kevlar	Villa 320	9585-0217-01	Stipa pack
1134-9170-01	8008989424123	C	Kevlar	Villa 520	9585-0219-01	Stipa pack
1134-9042-01	7313329130284	C	Rubber	Villa sweeper	9585-0068-01	Stipa pack
1134-9075-01	7313329130758	C	Rubber	Park 92 (2 WD)	9585-0130-01	Stipa pack
9585-0131-01	8008989446590	D	Rubber	Park 92M	-	No pack
9585-0164-01	7313329132127	D	Rubber	Park 95 Combi	-	No pack
1134-9006-01	7313329130024	D	Rubber	Park 100B, 100M	9585-0108-00	Stipa pack
1134-9066-01	7313329130635	D	Rubber	Park 100 Combi	9585-0125-01	Stipa pack
9585-0087-00	7313329130710	D	Rubber	Park 102M, Villa 102M	-	No pack
9585-0165-01	7313329132134	D	Rubber	Park 105 Combi	-	No pack
9585-0092-01	7313329130697	D	Rubber	Park 107M	-	No pack
9585-0132-01	7313329132103	D	Rubber	Park 107M, 107M HD	-	No pack
1134-9041-01	7313329130277	D	Rubber	Park 110 Combi Pro	9585-0067-00	Stipa pack
1134-9005-01	7313329130017	D	Rubber	Park 110S	9585-0106-00	Stipa pack
1134-9034-01	7313329130208	D	Rubber	Park 122B	9585-0073-00	Stipa pack
1134-9087-01	7313329130895	D	Rubber	Park 125 Combi Pro	9585-0142-00	Stipa pack
1134-9004-01	7313329130246	D	Rubber	Pony 6S, Pony 8S	9585-0101-00	Stipa pack
9585-0107-00	8008989446521	D	Rubber	Pony 8, 10	-	No pack
1134-9133-01	7313329131380	D	Rubber	Primo, Villa 320	9585-0173-01	Stipa pack
1134-9007-01	7313329130031	D	Rubber	Villa I 85B	9585-0118-00	Stipa pack
1134-9030-01	7313329130161	D	Rubber	Villa I 85M	9585-0071-00	Stipa pack
9585-0135-01	8008989446620	D	Rubber	Villa II 85M, Ready 85M	-	No pack
9585-0095-01	7313329131472	D	Rubber	Villa II 92M, Ready 92M	-	No pack
9585-0096-01	8008989446507	D	Rubber	Villa II 107M	-	No pack
9585-0133-01	8008989446606	D	Rubber	Villa II 107M	-	No pack
9585-0161-01	7313329132110	D	Rubber	Villa 85 Combi, Park 121M	-	No pack
9585-0162-01	8008989446705	D	Rubber	Villa 95 Combi	-	No pack
9585-0163-01	8008989446712	D	Rubber	Villa 105 Combi	-	No pack
1134-9171-01	8008989424130	D	Rubber	Villa 520	9585-0220-01	Stipa pack

# Starter Batteries & Chargers



1



2



3



4



5

Code	EAN	Pos	Description	Specification	Fits for	Note
9400-0086-00	8008989444923	1	Battery	18 Ah - L=200 W=088 H=164	Park, Villa	Neutral pack
1134-4804-01	7313329132073	2	Battery	18 Ah - L=180 W=075 H=167	Park, Ready, Villa	Neutral pack
1134-2892-01	8008989404781	3	Battery	24 Ah - L=180 W=122 H=175	Park, Tractor 12/39 4WS	Neutral pack
1134-5751-01	8008989418443	4	Battery	24 Ah - L=194 W=128 H=155	Park 4WD	Neutral pack
1134-4940-02	8008989413950	4	Battery	40 Ah - L=195 W=125 H=200	Park Pro Diesel	Neutral pack
1137-0640-01	8008989426608	5	Battery	24 Ah - L=194 W=128 H=155	-	Neutral pack

# Steering Wires

New Stiga Pack  
2015



### Packaging

DIMENSIONS: 23x13x5 cm  
GROSS WEIGHT: 0,170 Kg approx.

Code	EAN	Description	Tech info	Fits for	Note
1134-9021-01	7313329110781	Steering wire	-	Park 2000 (1975-83)	Neutral pack
1134-9022-01	7313329110798	Steering wire	-	Park 2000, Park 2002 (1984-89)	Neutral pack
1134-9084-01	7313329130857	Steering wire assy	Kit LH + RH	Park (1990-), Park compact, Park Compact 16, Park 320 M	Neutral pack
1134-9099-01	7313329131014	Steering wire assy	Kit LH + RH	Park Compact 4WD, Park Unlimited 14, Park Unlimited Plus, Park 340 MX	Neutral pack
1134-6380-03	-	Steering wire	-	Park Consumer, Parl Consumer High, Park Pro	Stiga pack
1134-6379-02	-	Steering wire	-	Park Pro, Park Pro 340 X	Stiga pack
1134-9138-01	7313329131434	Steering wire	-	Primo	Neutral pack
1134-9153-01	7313329131878	Steering wire	-	Ready, Villa (2004-2009)	Neutral pack
1134-9154-01	7313329131885	Steering wire	-	Ready, Villa (2010-), Villa 13, Villa 13 SHT	Neutral pack
1134-9023-01	7313329110828	Steering wire	-	Villa I	Neutral pack
1134-9083-01	7313329130840	Steering wire	-	Villa II w. wire steering	Neutral pack
1134-9085-01	7313329130864	Steering wire assy	Kit LH + RH	Villa II w. chain steering	Neutral pack
1134-6378-02	8008989421757	Steering wire	-	Villa 320, Villa 520, Villa 720	Stiga pack

# *Lawn Tractors*



# Belts

New Stiga Pack  
2015



Code	EAN	Type	Material	Fits for	Contains	Note
1134-9178-01	7313329620679	Engine - Gearbox	Rubber	Estate 6092 HW	-	Stiga pack
135062013/0	8008984507289	Engine - Gearbox	Rubber	Estate Baron, Tornado, 4092 H, 5092 H, 5102 H, Grand Tornado; ST: 102 H, 10216 H	-	Stiga pack
1134-9161-01	7313329131984	Engine - Gearbox	Rubber	Estate Basic, Tornado (-2007), Senator (-2006)	135062000/1	Stiga pack
135062012/0	8008989220039	Engine - Gearbox	Rubber	Estate Basic, Tornado (2008-), Collector, 2084, 3084, 4092, Senator (2007-), Senator 14 (2011-), SC 9214 (2011-), ST 10216 H (2011-), SC 92 B, SC 84 B, Classic 90, Collector 13,5, Collector 90, Master; SC: 84, 9013, 92 H, 9214B, 8414B	-	No pack
135062014/0	8008989220046	Engine - Gearbox	Rubber	Estate Tornado (2009-), Grand Tornado, Tornado 14, Grand Tornado 17 (2011-), Tornado 2098, Tornado 2108, Tornado 3098; SD: 9812, 10816 (2011-), 98 B, 108, 98 ST 102H, SC 9812B	-	No pack
135061980/0	8008984363212	Engine - Gearbox	Rubber	Estate Tornado HST (-2007), President, President H, President K	-	No pack
135062001/0	8008984331198	Engine - Gearbox	Rubber	Estate Tornado HST (2008-), President (2007-), Master HST, Grand Royal, Royal, Royal H, Royal special, Senator HST 17, Senator HST, Senator H HST, Senator HST special, Pro HST 17 (2011-), Baron, Royal, Royal 19 (2011-), Royal Pro 17 (2011-), Grand Royal 22 (2011-), Pro, SC 92H, Collector HST, Collector HST, Collector, Royal E, Royal H, Royal K, 3084 H, 3384 H, 6102 HW, 7102 HWS, 7122 HWS; SC: 84 H, 9013 H, 9216 H, 10214, 10216, 10216 H	-	No pack
135062002/1	8008989204367	Engine - Gearbox	Rubber	Estate Pro 2WD (2009-), Overland 4WD (2009-), Overland, Grand Overland Pro, Pro 4WD E, Grand Overland E, Grand Overland 4 WD Overland 22 4WD (2011-), Grand Overland 24E, Grand Overland 24 4WD, Pro 25 4WD W (2011-), Pro 25E, Pro 20 (2009), Pro 9102 XWS, Pro 9122 XWS	-	No pack
135061407/0	8008989204336	Engine - Gearbox	Rubber	Garden Combi, Combi PRO HST, Combi 3072 H	-	No pack
135061400/0	8008984292307	Engine - Gearbox	Rubber + laminated core	Garden Combi, Estate Master (-2003)	-	No pack
135061404/0	8008984388444	Engine - Gearbox	Rubber + laminated core	Garden Combi HST, Combi H HST, Combi, Combi PRO HST	-	No pack
135061406/0	8008984374270	Engine - Gearbox	Rubber	Garden Compact, Compact E, Compact EV, Compact Ethanol; SR: 6365, 6365 E	-	No pack
135061429/0	8008989220008	Engine - Gearbox	Rubber	Garden: Compact E HST, Compact E HST B, Combi 1066 H, Combi 1066 HQ, Tornado 1066 H	-	No pack
135062003/1	8008989220022	Engine - Gearbox	Rubber	SC 9812 B, SD: 108, 10816, 98, 9812, 9813, 9814, Tornado 2098 H, Tornado 2198 H, Tornado 3098 H, Tornado 3108 H, Tornado 5108 HW	-	No pack
119700062/0	8008989201564	Engine - Gearbox	Rubber	SR: 63EV, 6365EV, 6365B, 6365V, Compact EV, Compact Pro EV	-	No pack
135061427/0	8008989204343	Engine - Gearbox	Rubber	SR: 63EV, 6365EV, 6365B-6365V, Compact EV, Compact Pro EV, Compact Ethanol	-	No pack
135061430/0	8008989220015	Engine - Gearbox	Rubber	SR: 66 E, 66 EB	-	No pack
135062011/0	8008984358072	Engine - Gearbox	Rubber	ST 102, SC 10216B	-	No pack
135062811/0	8008984186217	Mower deck	Rubber	Estate Baron, Royal, Royal 19 (2011-), Royal Pro 17 (2011-); ST 10216 H (2011-), Pro 20, ST 102 B, 102 H, SC 10216B Overland, Overland 22 4WD (2011-), Overland 4WD, Royal special, Royal H, Overland 4 WD, ST 102, 5102 H, 6102 HW, 7102 HWS, PRO 9102 XWS	-	No pack
1134-9160-01	7313329131977	Mower deck	Kevlar	Estate Basic, Tornado, Tornado HST	135061503/0	Stiga pack
135065600/0	8008984182745	Mower deck	Rubber	Estate Baron, Royal, Royal 19, Pro 17, Pro 20, Overland 22 4WD (2011-), Overland, Overland 4WD, ST 10216H (2011-), Royal special, Royal H, ST 102, SC 10216 B, Overland 20, Overland 22, ST 102 B - H, ST 10214, 5102 H, 6102 HW, 7102 HWS, PRO 9102 XWS	-	No pack
135061404/0	8008984388444	Mower deck	Rubber + laminated core	Garden Combi HST, Garden Combi Pro HST, Combi H HST	-	No pack
135061423/0	8008984378285	Mower deck	Rubber	Garden Combi, Combi HST, Combi H HST, Combi HST 14, Pro HST 13 (2011-), Combi PRO HST, Combi 3072 H; Estate: Master, Master HST	-	No pack
135061428/0	8008989219996	Mower deck	Rubber	Garden Compact, Compact E HST, Compact E HST B, Combi 1066 H, Combi 1066 HQ, Tornado 1066 H, SR 66 E, SR66 EB	-	No pack
135061508/0	8008989200109	Mower deck	Rubber	Estate Master, Master HST, 2084, 3084, 3084 H, 3384 H, Classic 90, Collector 13,5, Collector 90, Collector, Collector HST (-2010), President, Senator - HST, Senator H HST, PRO, PRO H, PRO HST, SC 9013, SC 9013H, SC 92, SC 92H, SC 92B, SC 9214, SC 9214 B, SC 9216 H, ST 10216, 4092, 4092 H, 5092 H, SC: 84, 84 B; SC: 84 H, SC 8414B, Mirage 5.0, 6092 HW	-	No pack
135061506/0	8008989204350	Mower deck	Rubber	Estate Grand Tornado, Grand Tornado HST, Grand Tornado H HST, Grand Tornado PRO HST, Tornado 2108, Tornado 3108 H; SD: 108, SD 18016, Tornado 5108 HW	-	No pack
135061504/0	8008984507302	Mower deck	Rubber	Estate Tornado (2009-), Tornado 14, Tornado HST, Tornado HST 17, Tornado 2098, Tornado 2098 H, Tornado 2198 H, Tornado 3098, Tornado 3098 H, Pro HST 13 (2011-); SD: 9812, 9814 H (2011-), 98 B, 98, 98 H; SC: 9812 B, 9813, 9814	-	No pack
135062812/0	8008984248748	Mower deck	Rubber	Estate Pro 25, Pro 22, Pro 22E, Grand Royal 22 (2011-), Overland, Grand Overland 24E, Grand Overland 24 4WD, Grand Overland Pro 25 4WD E (2011-), Grand Overland, Grand Overland E, Grand Overland PRO, Grand Overland PRO 4WD E, Grand Royal, Royal, 7122 HWS, PRO 9122 XWS	-	No pack
135065601/0	8008984248755	Mower deck	Rubber	Estate Pro 25, PRO 22, PRO 22E, Estate Royal, Gran Royal 22 (2011-), Overland, Grand Overland 24 E, Grand Overland 24 4WD, Grand Overland E, PRO, PRO 4WD, 7122 HWS, PRO 9122 XWS	-	No pack

# Blades

New **Stiga Pack**  
2015



### Packaging (pos. 11)

DIMENSIONS:

13,2x73,5x4 cm

GROSS WEIGHT:

1,2 Kg approx.

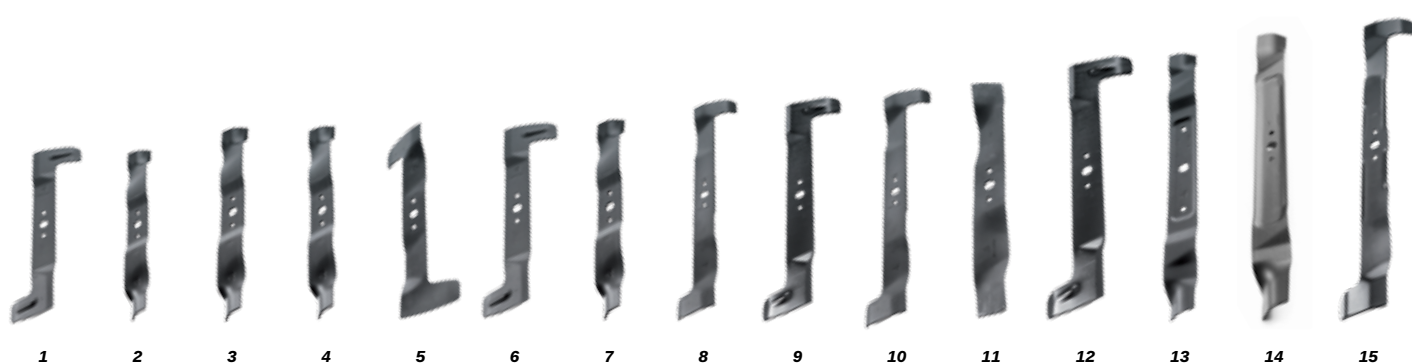

Code	EAN	Pos	Description	Lenght	Type	Fits for	Width	Note
184109504/0	8008989220800	13	Blade	618 mm	mulching	Garden: Compact, Compact Pro EV (2011-), Compact EV special, Compact H EV; SR: 6365, 6365 EV (2011-)	63 cm	Neutral pack
184109505/0	8008989220817	14	Blade	649 mm	mulching	SR: 66E, 66 EB, Garden: Compact E HST, Compact E HST B, Combi: 1066H, 1066HQ, Tornado 1066H	66 cm	Neutral pack
184109503/0	8008984957954	15	Blade	707 mm	mulching winged	Garden: Combi, Combi HST 14, Combi HST, Combi H HST, Pro HST 13	72 cm	Neutral pack
184109502/0	8008984390874	15	Blade	707 mm	mulching	Garden: Combi, Combi HST 14, Pro HST 13	72 cm	Neutral pack
182004358/0	8008989200024	1	Blade-RH	418 mm	mulching winged	SC84, SC 84 B	84 cm	Neutral pack
182004359/0	8008989200031	1	Blade-SH	418 mm	mulching winged	SC84, SC 84 B	84 cm	Neutral pack
182004360/0	8008989200048	2	Blade-RH	418 mm	mulching	Estate Master	84 cm	Neutral pack
182004361/0	8008989200055	2	Blade-SH	418 mm	mulching	Estate Master Hst	84 cm	Neutral pack
182004353/0	8008984969919	5	Blade-LH	460 mm	mulching winged	Estate Collector, President, Senator, Senator 14, HST 17, Pro HST 17 (2011), Senator HST, Senator HST Special, Senator H HST; SC: 9013, 9214, 92H, 92 B, 6092 HW	92 cm	Stiga pack
182004354/0	8008984969926	5	Blade-RH	460 mm	mulching winged	Estate Collector, President, Senator, Senator 14, HST 17, Pro HST 17 (2011), Senator HST, Senator HST Special, Senator H HST; SC: 9013, 9214, 92H, 92 B, 6092 HW	92 cm	Stiga pack
181004346/3	8008984952997	3	Blade-LH	456 mm	mulching	Estate Collector, Senator, President, SC: 9013, 9214 (2011-)	92 cm	Neutral pack
182004352/0	8008984945548	4	Blade-RH	457 mm	mulching	Estate Collector, Senator, President, SC: 9013, 9214 (2011-)	92 cm	Neutral pack
182004344/1	8008984359413	4	Blade-LH	457 mm	winged	Estate Collector, Senator, President, SC: 9013, 9214 (2011-)	92 cm	Neutral pack
182004345/1	8008984359420	6	Blade-RH	458 mm	winged	Estate Collector, Senator, President, SC: 9013, 9214 (2011-)	92 cm	Neutral pack
182004346/0	8008984386709	7	Blade	486 mm	mulching	Estate Tornado, Tornado 14, HST 17, Pro HST 13; SD: 9813, 9812 (2011-), 9814 H (2011-), 98 B	98 cm	Neutral pack
182004347/0	8008984387331	8	Blade-LH	517 mm	mulching winged	Estate Royal, 19 (2010-), Pro 17 (2010-), Pro, Overland, Overland 22 4WD (2010-), Royal special, Royal H, Overland 4WD; ST: 10214, 10216 H (2011-), 102	102 cm	Neutral pack
182004348/0	8008984387348	8	Blade-RH	517 mm	mulching winged	Estate Royal, 19 (2010-), Pro 17 (2010-), Pro, Overland, Overland 22 4WD (2010-), Royal special, Royal H, Overland 4WD; ST: 10214, 10216 H (2011-), 102	102 cm	Neutral pack
182004340/1	8008984360006	9	Blade-LH	518 mm	winged	Estate Royal, Royal 19 (2010-), Pro 17 (2010-), Pro, Overland, Overland 22 4WD (2010-); ST 10214	102 cm	Neutral pack
182004341/1	8008984360013	9	Blade-RH	518 mm	winged	Estate Royal, Royal 19 (2010-), Pro 17 (2010-), Pro, Overland, Overland 22 4WD (2010-); ST 10214	102 cm	Neutral pack
182004357/0	8008984504073	11	Blade	533 mm	mulching winged	Estate Grand Tornado 17, HST 19, Pro HST 17 (2011-), Grand Tornado, Grand Tornado HST, Grand Tornado H HST; SD: 108 H, 10816, 5108 HW, Tornado 5108 HW	108 cm	Stiga pack
182004349/0	8008984387355	10	Blade-LH	617 mm	mulching winged	Estate Grand Royal 22, Grand Overland 24E/24 4WD/Pro 25 4WD E (2010), Grand Royal, Grand Overland 4WD/ PRO 4WD E, PRO 9122 HWS	122 cm	Stiga pack
182004350/0	8008984387362	10	Blade-RH	617 mm	mulching winged	Estate Grand Royal 22, Grand Overland 24E/24 4WD/Pro 25 4WD E (2010), Grand Royal, Grand Overland 4WD/ PRO 4WD E, PRO 9122 HWS	122 cm	Stiga pack
182004342/0	8008984248762	12	Blade-LH	618 mm	winged	Estate Grand Royal 22, Grand Overland 24E/24 4WD/Pro 25 4WD E (2010-)	122 cm	Neutral pack
182004343/0	8008984248779	12	Blade-RH	618 mm	winged	Estate Grand Royal 22, Grand Overland 24E/24 4WD/Pro 25 4WD E (2010-)	122 cm	Neutral pack

## Blade Holders



1



2



3

Code	EAN	Pos	Description	Tech info	Fits for	Use with Nuts&Bolts	Contains	Note
1134-3744-01	8008989407690	1	Blade holder	Ø 20; Ø 8.5 x4	Garden 72M Multiclip, Garden Combi	Type C	-	Neutral pack
1134-9159-01	7313329131960	2	Blade holder	Ø=20 mm	SC 9214-84-92H, SD 9812-9814 H-10816, ST 10216 H, Garden Combi, Estate, Estate Master, Master HST, Senator HST Special, Senator HST, Estate Tornado, Tornado HST, Grand Tornado, Grand Tornado H HST, Grand Tornado HST, Estate Royal, Royal special, Royal H, Grand Royal, Estate Senator H HST, Overland, Grand Overland 4WD, Grand Overland PRO 4WD E Grand Overland Ride-On Mowers, Estate 6092 HW, Estate Pro 9122 HWS, Tornado 5108 HW	Type K	125463200/0	Stiga pack
1134-9061-01	7313329130574	3	Blade holder assy	Ø=20 mm	Scoop	Type C	1 pcs	Stiga pack
327787045/1	8008984528758	-	Blade support holder	-	Garden Compact, Garden Compact E, Garden Compact Ethanol, Garden compact Ethanol EV, Garden Compact EV	Type L	-	Neutral pack

## Starter Batteries & Chargers



1



2



3



4



5

Code	EAN	Pos	Description	Specification	Tech info	Fits for	Note
118120004/0	8008984379107	1	Battery	7,2 Ah - L=150 W=065 H=095		Garden Compact E	Neutral pack
9400-0086-00	8008989444923	1	Battery	18 Ah - L=200 W=088 H=164		Garden	Neutral pack
118120012/0	8008989215738	2	Battery	7,2 Ah - 12 V		Combi 1066 H/1066 HQ, Tornado 1066 H	Neutral pack
1134-4804-01	7313329132073	3	Battery	18 Ah - L=180 W=075 H=167		Garden, Estate	Neutral pack
182180090/0	8008989200116	4	Charger	600 mA	EU-plug	Villa 320/520, Park, Ready, Villa, Garden, Estate	Neutral pack
182180091/0	8008989205135	4	Charger	600 mA	UK-plug	Villa 320/520, Park, Ready, Villa, Garden, Estate	Neutral pack
182180051/0	8008984374874	5	Charger	200 mA	EU-plug	Garden Compact, SR66, Combi 1066 H/1066 HQ, Tornado 1066 H	Neutral pack
182180053/0	8008989205128	5	Charger	200 mA	UK-plug	Garden Compact, SR66, Combi 1066 H/1066 HQ, Tornado 1066 H	Neutral pack

## Care

New Stiga Pack  
2015



**Packaging**  
DIMENSIONS:  
20x28x16,5 cm  
GROSS WEIGHT:  
1,525 Kg



Code	EAN	Description	Features	Measures	Note
1134-9177-01	7313329132158	Protective cover for RO	Grey Stiga logo	250x125x130 cm	Stiga pack



# *Snow Throwers Scarifiers, Tillers*



# Belts

## Snow Throwers

Code	EAN	Type	 Fits for	Note
1812-9009-01	7313329180142	Drive train	521 (1983-87), 523 (1988-94)	Stiga pack
1812-9016-01	7313329180104	Drive train	522 (1995-96), 524 (1994-99), 725 (1996), Snow Master, Snow Buster, Snow King, Snow Storm, Snow Blizzard, Snow Spark, Snow Hurricane, Snow Track, Snow Unltd, Snow Flake, Snow Power, Snow Super, 827 (1994-96), 827T (1994-95), 928 (1997, 2000-02), 928T (2000-02), 1030 (1994-96), 866 (2004-), 1130 (1997), 1384 (2002-), 966D, 1174 Track, 1384D	Stiga pack
1812-9010-01	7313329180098	Drive train	725T, 825T (1986-93)	Stiga pack
1812-9008-01	7313329180135	Drive train	825 (1983-93)	Stiga pack
1812-9015-01	7313329180180	Drive train	828 (1988-93), 1132 (1983-87), 1232 (1988-93)	Stiga pack
1812-9024-01	7313329180241	Drive train	928E, 928ET (1998-99), 1130E (1998), 1330E (1999), 1333 (2000-01)	Stiga pack
1812-2220-01	8008989624585	Drive train	966D (2006-), Snow Blizzard, Snow Flake, Snow Power, Snow Spark Drive train, Snow fox	Stiga pack
1812-9027-01	7313329180289	Drive train	1174HST (2002-2007)	Stiga pack
1811-2090-01	8008989607908	Drive train	Snow Fall (2004-2005) drive train	Stiga pack
1812-2515-01	8008989627210	Drive train	Snow Flake, Snow Power (2012-)	Stiga pack
1811-2410-01	8008989609728	Drive train	Snow Rise (2006- ), Snow Cube, Crystal (2007-)	Stiga pack
1812-9025-01	7313329180067	Auger	320 (1997), 321 (1998), 521 (1999), Snow Star (1999-), Snow Max (2000-)	Stiga pack
1812-9012-01	7313329180111	Auger	521 (1985-87), 523 (1988-93), 524 (1994), 725T (1988-93), 827T (1994)	Stiga pack
1812-9021-01	7313329180210	Auger	725 (1996), 827T (1995)	Stiga pack
1812-9013-01	7313329180166	Auger	825 (1985-93), 825T (1986-93)	Stiga pack
1812-9017-01	7313329180197	Auger	827 (1994)	Stiga pack
1812-9020-01	7313329180081	Auger	827 (1995-96), Snow Buster, Snow King, Snow Spark, Snow Storm, Snow Blizzard, Snow Unltd, Snow Hurricane, Snow Track, Snow Flake, Snow Power, Snow Super, 928 (1997, 2000-02), 866 (2004-), 1174HST (2002-), 1384 (2002-), 966D, 1174 Track, 1384D	Stiga pack
1812-9014-01	7313329180173	Auger	828 (1983-93), 1132 (1983-87), 1232 (1989-93)	Stiga pack
1812-9023-01	7313329180234	Auger	928E (1998-99), 1130E (1998), 1330E (1999), 1333 (2000-01)	Stiga pack
1812-9022-01	7313329180227	Auger	928ET (1998-99)	No pack
1812-2232-01	-	Auger	966D, 1171 HST, 1381 HST (2006-2013)	No pack
1812-1878-01	8008989621386	Auger	Snow Breeze (2004-2006), Snow Frost (2007-)	No pack
1811-2578-01	8008989611424	Auger	Snow Crystal (2007- )	No pack
1811-2135-01	8008989608325	Auger	Snow Electr. (2004-2005)	No pack
1811-2307-01	8008989608783	Auger	Snow Electr. 1300 (2006-)	No pack
1811-2356-01	8008989609322	Auger	Snow Electr. 2000 (2007-)	No pack
1811-2091-01	8008989607915	Auger	Snow Fall (2004-2005)	No pack
1812-2784-01	8008989629399	Auger	Snow Fox	No pack
1812-9026-01	7313329180272	Auger	Snow Master (2001-2003), 522 (1995-96), 524 (1997-99), Snow Master (2000)	No pack
1812-2566-01	8008989627692	Auger	Snow Prisma	No pack
1811-2579-01	8008989611431	Auger	Snow Cube (2012- )	No pack
1812-2012-01	8008989622642	Auger	Snow Rex (2005-)	No pack
1811-9014-01	7313329180357	Auger	Snow Rise (2006-2009 ), Snow Cube (2007-2011 )	No pack

## Scarifiers

Code	EAN	Type	 Fits for	Note
1319-1918-01	8008989230076	Transmission	VB 40	No pack
1716-0221-01	8008989602422	Transmission	VE 30, RE 30	No pack
1716-0015-01	8008989600657	Transmission	VE 32	No pack

## Tillers

Code	EAN	Type	 Fits for	Note
1483-2034-01	8008989640714	Transmission	Silex 40-G, 40R-G	No pack
1483-2036-01	8008989640738	Transmission	Silex 40R-G, 50R-B	No pack
1483-2035-01	8008989640721	Transmission	Silex 50-G, 50-H, 50R-B	No pack
1483-2149-01	8008989642008	Transmission	Silex 75-G, 75R-B, 75R-H, 75R-HX	No pack
1483-2141-01	8008989641933	Transmission	Silex 75R-B, 75R-H, 75R-HX	No pack
1483-2263-01	8008989643241	Transmission	Silex 82R-HX	No pack
1483-2264-01	8008989643258	Transmission	Silex 82R-HX	No pack
1483-2352-01	8008989644149	Transmission	Silex 87B, 95B, 95H petrol scythe	No pack
1483-2350-01	8008989644125	Transmission	Silex 87B petrol scythe	No pack
11880001/0	8008989216117	Transmission	Silex 95 B, 95 H	No pack
1483-2137-01	8008989641896	Transmission	Silex 360-G	No pack
1483-2113-01	8008989641612	Transmission	Silex 500-G, 500R-G	No pack
1483-2114-01	8008989641629	Transmission	Silex 500R-G	No pack



# *Engine Parts*



# Filters

The aim of the filter is filtering the air that is channelled from the outside to the combustion chamber, getting rid of all impurities. A non-perfectly clean air filter can affect the performance and life of the engine itself. It is therefore vital to check it and replace it when dirty. The Stiga range includes filters suitable for each type of machine.



Code	EAN	Pos	Description	Fits for	Contains	Note
1111-9152-01	7313329113201	1	Air filter	V 35, SV 40, RV 45, RM 45	18550011/0	Neutral pack
1111-9170-01	7313329113409	2	Air filter	OM 65, RM 65 (2007- )	18550187/0	Neutral pack
1134-9162-01	7313329131991	3	Air filter	WM 13,5, WM 14,5, WM 16	118550199/0	Neutral pack
1134-9163-01	7313329132004	4	Air filter	WM 12,5	118550321/0	Neutral pack
1111-9204-01	7313329114727	5	Air filter	OM 55, RM 55, SA 55, SA 65 (160+196 cc)	118550257/0	Neutral pack
1111-9169-01	7313329113393	6	Air filter	RM 45 (2007- )	18550147/0	Neutral pack
1111-9205-01	7313329114734	7	Air filter	SA 45 (140 cc)	118550452/0	Neutral pack
118550704/0	8008989102953	8	Air filter	RSC100	-	Neutral pack
118550748/0	8008989506645	9	Air filter	RSC100, RSCT100	-	Neutral pack
118550354/1	8008989502326	10	Fuel filter	-	-	Neutral pack

# Spark Plugs

The Stiga spark plugs are suitable for all 2 and 4 stroke engines from the Stiga machines. In particular the GGP K7RTC spark plug has been designed specifically for the GGP 100 cc engine fitted on all lawnmowers and tillers. These spark plugs reduce the formation of combustion deposits therefore reducing the risk of faulty ignition and internal faults. They have a long life and are highly resistant to vibrations.



Code	EAN	Pos	Type	Fits for	Note
9400-0225-00	7313329111849	1	J19LM	Most walk-behind mowers, GGP-engine V35, SV40, RM45	Neutral pack
1111-9028-02	7313329110965	1	J19LM	Most Walk-Behind Mowers, GGP-engine V35, SV 40, RM45	Stiga pack
3210060	5010874509481	2	RJ19LM	Most Walk-Behind Mowers, GGP-engine V35, SV40, RM45 - W. Anti-Interference Resistor	Neutral pack
9400-0289-01	7313329114796	3	RN9YC	Honda GCV135, GCV160, GGP-engine OM60, RV/RM 65	Neutral pack
1111-9154-01	7313329113225	3	RN9YC	Honda GCV135, GCV160, GGP-engine OM60, RV/RM 65	Stiga pack
9400-0303-01	8008989445074	4	RN11YC4	Honda GCV520, GCV530	Neutral pack
1111-9206-01	7313329114741	5	RC12YC	Park 16, Park 18HST, Park Pro 16, 18, 20, Royal (B&S), Multiclip Pro 51S, GGP WM, GGP OM55	Stiga pack
9400-0244-00	7313329114789	5	RC12YC	Park 16, Park 18HST, Park Pro 16, 18, 20, Royal (B&S), Multiclip Pro 51S, GGP WM, GGP OM55	Neutral pack
3210022	5010874504219	6	CJ7Y	<b>Chain Saw</b> 955, SP: 340, 370, 410, 460, 510, 382, 472, 522 SPR: 270, 270C; <b>Brushcutter</b> ST: 210, 26J, SB: 22, 28, 26, 26JD, 29S, 29DS, 30, 40, 52, 34, 34D, 35S, 35DS, 43S, 51DS B.J: 325, 325D, 335, 335D, 345D	Neutral pack
9400-0278-00	8008989445012	7	CJ8Y	<b>Tiller</b> JB20, JB25 <b>Snow thrower</b> 321, 521, Snow Star, Snow Max	Neutral pack
9400-0259-00	7313329114925	8	DJ6J	-	Neutral pack
9400-0260-00	8008989136248	9	DJ7J	-	Neutral pack
9400-0226-00	7313329112099	10	DJ7Y	<b>Trimmer</b> 6000, 7000, 8000 <b>Trimmer</b> 6000, 7000, 8000	Neutral pack
9400-0261-00	7313329111382	11	DJ8J	<b>Chain saw</b> 930, 935, 940, <b>Trimmer</b> ST270, ST280, ST311, SD31, Brush cutter Pro 41, 47, SD2500, 3100, 4100	Neutral pack
123051000/0	8008989343974	12	RZ7C	<b>Trimmer</b> 27, 29, 32, 35 <b>Chain Saw</b> SP: 350, 352, 400, 442 <b>Trimmer</b> 27, 29, 32, 35 <b>Chain Saw</b> SP: 350, 352, 400, 442	Neutral pack
118550658/0	7313329114772	13	K7RTC	GGP 100 cc	Neutral pack
3210024	8008984519015	14	RCJ7	SBK: 27, 27D, 35, 35D, 45, 45D, 53	Neutral pack

A close-up photograph showing a person's hands pouring orange motor oil from a large plastic jug into the oil filler neck of a vehicle. The jug has a green handle and a green cap. The oil is being poured into a black plastic filler neck. The background is a blurred outdoor setting with green grass. The text "Lubricants & Cans" is overlaid in a white box in the center of the image.

# *Lubricants & Cans*

## Chain Oil

Stiga offers high quality oil available in bottles of various sizes to meet any kind of requirement. The Stiga chain oil is vital to avoid excessive friction between the bar and the chain that might cause wear and tear as well as damages.



Code	EAN	Pos	Type	Specifications	Capacity	PCS per Box
1111-9149-01	7313329113102	1	Mineral	-	1,4 lt	9
1111-9150-01	7313329113119	2	Mineral	-	4 lt	3

## 2 Stroke Oil

The engine oil aims at protecting metal surfaces from wear and reducing the friction of the mechanical elements touching and moving one against the other. Even more oil helps with cooling the mechanisms transferring the heat from the hotter to the cooler areas, keeps mechanical elements clean preventing the formation of any deposits, keeping contaminants suspended and sealing piston rings and cylinders. For this reason engine oil must be checked and replaced as required. Stiga propose in his range 2-stroke engine oils syntetic and semi-syntetic. Syntetic ones are API TC (mineral-based, good quality, designed specifically for air-cooled engines) and JASO FC (high quality, high lubrication power, low spark plug dirt, less cylinder residues, less fumes and therefore better engine performance). Semi-syntetics oils are API TC ++ that means that they have the better specifications, so they are the best in terms of quality.



Code	EAN	Pos	Type	Specifications	Capacity	PCS per Box
1111-9160-01	7313329113300	1	Semi-Synthetic	API TC++/JASO FC	0,1 lt	25
1111-9148-01	7313329113096	2	Semi-Synthetic	API TC++/JASO FC	0,6 lt	12
1111-9176-01	7313329118121	3	Synthetic	API TC/JASO FC	1 lt dozer	12
1111-9177-01	7313329114444	4	Synthetic	API TC/JASO FC	1 lt	24

## 4 Stroke Oil

Stiga 4 stroke engine oils offers different kinds of oils. SAE 30 is superb for use with 0° - 30° outside temperatures, the specifications API CF/SG mean that is good for both gasoline and diesel engines. SAE 20W-50 is a very dense oil, which can cover the spaces between the sliding parts thanks to its constant viscosity. SAE 10W-30 designates a multi-grade oil. The first number '10W' is the viscosity of the oil at cold temperature and the second number is the viscosity at 100 °C. SAE 5W-50 allows a reduction in fuel consumption due to its special viscosity at both high and low temperatures. It has an excellent viscosity behaviour when cold.



Code	EAN	Pos	Type	Specifications	Capacity	PCS per Box
1111-9140-01	7313329112747	1	Mineral SAE 30	API SG/CF	0,6 lt	12
1111-9141-01	7313329112761	2	Mineral SAE 30	API SG/CF	1,4 lt	9
1111-9147-01	7313329113089	3	Mineral SAE 20W-50	API SG/CD	4 lt	3
1111-9171-01	7313329113539	4	Semi-Synthetic SAE 10W-30	API SL/CF	0,6 lt	12
1111-9146-01	7313329113072	5	Semi-Synthetic SAE 10W-30	API SL/CF	1,4 lt	9
1111-9144-01	7313329113058	6	Synthetic SAE 5W-30	API SM/CF	1,4 lt	9

# Transmission Oil

Transmission oil plays a key role in ensuring the availability and usability of the power generated by the motor, since it ensures the functioning of transmissions under harsh conditions in terms of temperatures and loads on the gears. Stiga transmission oil is a multigrade oil that guarantees viscosity at both very high and low temperatures, making it a very versatile and high-performance oil.



Code	EAN	Pos	Type	Specifications	Capacity	PCS per Box
1111-9220-01	7313329114918	1	Synthetic SAE 5W-50	-	1,4 lt	9
1111-9145-01	7313329113065	2	Synthetic SAE 5W-50	-	4 lt	3

## Cans

The yellow fuel **can** is certified for land and sea transport. The dispenser allows the liquid to run out continuously without any over-flowing. The cap has special seals suitable to be in contact with the various types of hydrocarbons. The **combican** canister holds 5 litres of petrol and 2 litres of oil. It is fitted with an effective anti-overflow device so that filling is stopped automatically when the tank is full. The 2 cans can be separated.

### New Stiga Pack 2015



1

DIMENSIONS:  
28x19x18 cm  
GROSS WEIGHT:  
0,500 Kg



2

DIMENSIONS:  
31x29,5x15 cm  
GROSS WEIGHT:  
1,065 Kg

### Instructions for Can

#### For Fuel

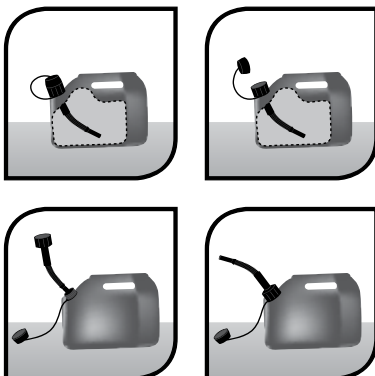

### Instructions for Combican

#### For Oil/Fuel

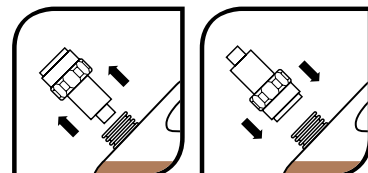

#### For Fuel

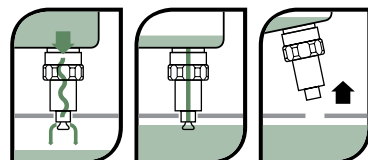

Code	EAN	Pos	Type	Capacity
1111-0001-01	7313329115038	1	Can	5 lt
1911-9144-01	7313329191209	2	Combican	5 lt + 2 lt



# Technical Section

<b>Lawn Mowers</b> .....	41
Friction Blade Holders.....	41
Cables.....	41
<b>Front Mowers &amp; Lawn Tractors</b> .....	46
Nuts & Bolts.....	46
Belt Pulleys.....	47
Tension Rollers.....	48
Lifting Devices.....	48
Casing Wheels - Guard Rollers.....	48
Other.....	49
Electric Parts.....	49
Cables.....	50
<b>Snow Throwers</b> .....	55
<b>GGP Engines</b> .....	55
<b>Others</b> .....	55
<b>Special Screw Drivers</b> .....	56
<b>Spark Plug Wrenches</b> .....	56
<b>Belt Holders</b> .....	56
<b>Service Tools</b> .....	57



# Lawn Mowers

## Friction Blade Holders



Part Nr.	Pos	Description	Tech info
322672110/1	1	Friction washer	Ø = 60 mm
322672111/0	2	Friction washer	Ø = 55 mm

## Throttle cables

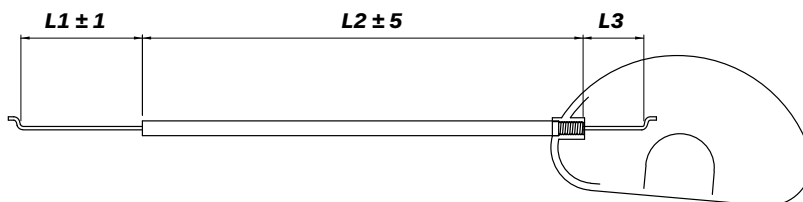

Part Nr.	Description	Fits	Note (mm)
481007080/0	Throttle cable	Dino 47/47B; Multiclip 53 S Rental B (2011-)/50/50 B/50 Plus/50S Plus/50S Rental/50SE Rental B/50S Special B (2011-)	L1= 50 - L2= 1755 L3= 25

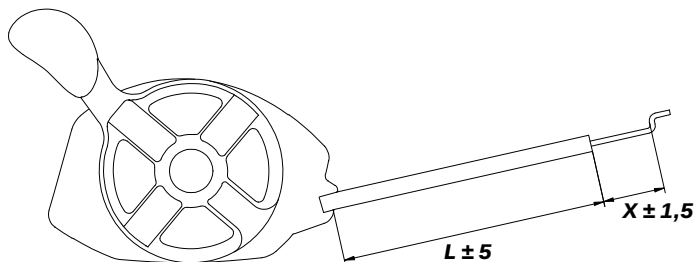

Part Nr.	Description	Fits	Note (mm)
181005501/1	Throttle cable	Combi 48 SQ BW/ Combi 53 SQ BW/53 SEQ BW / Turbo X3 50 S (2011-)	L= 1100 - X= 54
181005502/1	Throttle cable	Combi 48 SQ BW B/48SQ B/53 SQ B - Combi 53 SQ BW B - Turbo 53 S BW Plus B - Turbo Excel 50 S B/50 SE B (2011-), EXCEL 50 S B	L= 1440 - X= 48
181005503/1	Throttle cable	Turbo X3 50 S H (2011-)	L= 1480 - X= 54
181005509/0	Throttle cable	Turbo Excel 55 S B; Turbo X3 55 S B (2011-)	L= 1480 - X= 54
181005513/0	Throttle cable	Turbo 53 S BW Plus H (2011-)/53 S H	L= 1070 - X= 54
181005514/0	Throttle cable	Turbo 48 Plus H (2011-)	L= 1035 - X= 54
181005515/0	Throttle cable	Turbo 48 S BW Plus H (2011-)/48 S H	L= 1035 - X= 54
181005516/0	Throttle cable	Turbo 48 Plus B; Turbo 48 S BW Plus B (2011-)/ 48 S B	L= 1390 - X= 48
181005508/0	Throttle cable	Collector 53 S B	L= 1480 - X= 48
181005510/0	Throttle cable	TURBO EXCEL 55 S H	L= 1160 - X= 49
181005511/0	Throttle cable	Combi 48 B/SB, Multiclip 50 B/SB, Multiclip Euro 50 B	L= 1355 - X= 48
181005512/0	Throttle cable	Combi 53	L= 1070 - X= 54
181005517/0	Throttle cable	Combi 48, Combi 48 S, Multiclip 50/50S/50SE, Multiclip Euro 50 H (- 2013), Multiclip 47	L= 1020 - X= 54
181005520/1	Throttle cable	EXCEL 50 S4Q INOX B, TURBO EXCEL 55 S B, 50/50 S	L= 1480 - X= 51
181005525/0	Throttle cable	Combi 53 S B	L= 1010 - X= 54
181005523/1	Throttle cable	Excel 55 SQ B	L= 1310 - X= 49

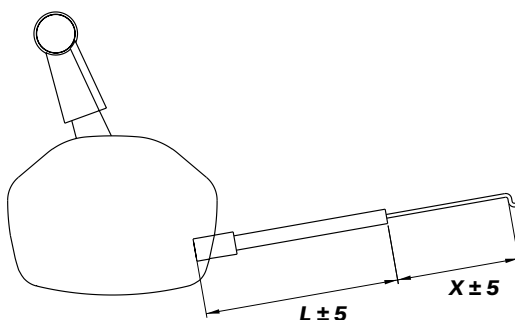

Part Nr.	Description	Fits	Note (mm)
181007126/0	Throttle cable	Turbo 50 S Rental H (2011-)	L= 1040 - X= 37
181007130/0	Throttle cable	Multiclip 50 S H (2011-)	L= 1010 - X= 37
181007145/0	Throttle cable	Turbo Power 50 SB / 53SB	L= 1380 - X= 60

# Lawn Mowers

## Throttle cables

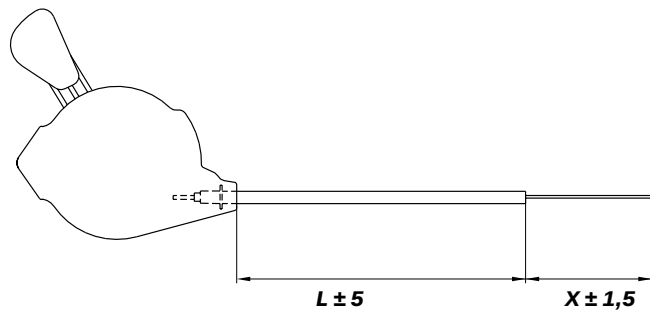

Part Nr.	Description	Fits	Note (mm)
181007128/0	Throttle cable	Turbo 50 S Rental B (2011), Turbo 55 S Rental B (2011)	L= 1270 - X= 60

## Blade Brake Clutch Cable

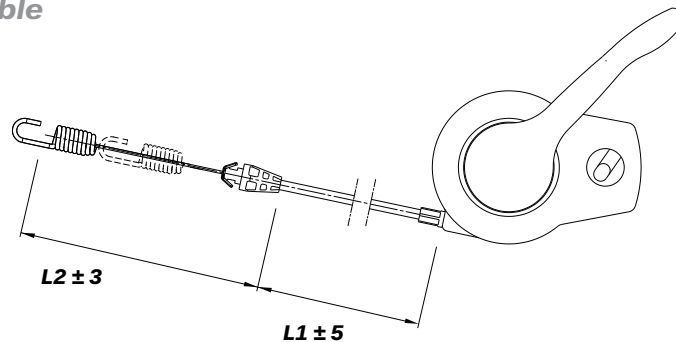

Part Nr.	Description	Fits	Note (mm)
381030064/0	Blade brake clutch cable	Excel 55 SQ B BBC	L1= 1430 - L2= 141

## Thread Engine Brake Cables

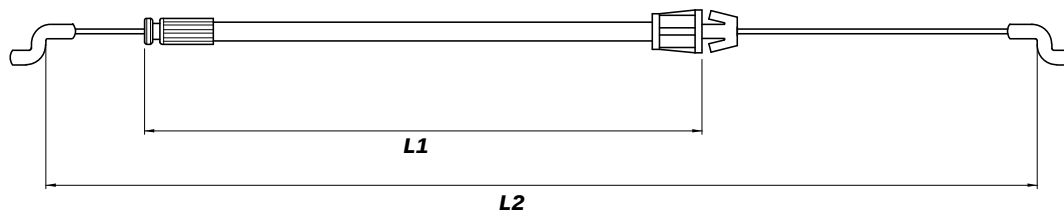

Part Nr.	Description	Fits	Note (mm)
181000692/0	Thread engine brake cable	Turbo 50 S Rental B- Turbo 55 S Rental B (2011-), Turbo Pro 50 S B	L1= 1050 - L2= 1277
181000730/0	Thread engine brake cable	Multiclip 53 S Rental B (2011-)	L1= 930 - L2= 1157
181000769/1	Thread engine brake cable	Multiclip Pro 50 Svan/Pro 50 S Svan/Pro 50 4S Inox Svan/Pro 53 S Svan/Pro 53 4S Svan (2011-)	L1= 970 - L2= 1206
181030065/0	Thread engine brake cable	Turbo Excel 50 S B/50 SE B/55 S B/55 SQ B; Turbo X3 50 S/X3 50 S H/X3 55 S B (2011-), EXCEL 50 S B /50 S4Q INOX B	L1= 1185 - L2= 1372
181030061/0	Thread engine brake cable	Turbo 50 S Rental H; Turbo Pro 55 4S (2011-); Turbo Pro 50 S, Turbo Pro 55 S4 B	L1= 1050 - L2= 1282
181030066/0	Thread engine brake cable	Turbo Excel 50 S H AVS/Excel 55 S H AVS/ Excel 55 S H BBC (2011-), Excel 50 S4Q B/55 SQB BBC	L1= 1150 - L2= 1374
181030053/0	Thread engine brake cable	Combi 48 SQ BW/48 SQ B; Combi 53 SQ BW/53 SQ B; Combi 53 SEQ BW; Combi 48 SQ BW B; Combi 53 SQ BW B (2011-), Collector 46/46S/46B/46 SB/46 SH	L1= 1150 - L2= 1313
181030073/0	Thread engine brake cable	Turbo 48 Plus B/48 SB/48 SH/48 S BW Plus B/48 Plus H/48 S BW Plus H (2011-)	L1= 1085 - L2= 1241
181000733/0	Thread engine brake cable	Multiclip 50 S H (2011-)	L1= 927 - L2= 1101
181030074/0	Thread engine brake cable	Turbo 53 S BW Plus B; Turbo 53 S BW Plus H (2011-)/53 SH	L1= 1125 - L2= 1311
181000618/0	Thread engine brake cable	Multiclip 50 Rental B/50 S Rental B/50 SE Rental B/50 S Special B/50 Plus/50 S Plus/ 50 SE Plus/ 50 S Rental (2011-)/50 SE B Plus/50 SEV B Plus	L1= 1000 - L2= 1227
181030056/0	Thread engine brake cable	Combi 48/48S/48B /48SB, Multiclip 47/50/50S/50B/50SB/50H/50SH, Multiclip Euro 50 B/H/50SE/50H Collector 43/48/48S/48B/48SB/48SQB	L1= 1082 - L2= 1275
181030057/0	Thread engine brake cable	Collector 53 SB	L1= 1192 - L2= 1385
181030077/0	Thread engine brake cable	Turbo Power 50SB/53SB/53SH	L1= 1040 - L2= 1233
181030087/0	Thread engine brake cable	Combi 53 S, 53 SB	L1= 1040 - L2= 1308
181030069/1	Thread engine brake cable	Multiclip 50 Blue/ 50S Blue/50B/50SB, Multiclip 47 QH	L1= 1087 - L2= 1284
181030070/0	Thread engine brake cable	Combi 48 SQH/ 53 SQH	L1= 1150 - L2= 1347
181030099/0	Thread engine brake cable	Turbo 48 SB/48 SEB/48 SH/ 48 SEV Q B	L1= 1050 - L2= 1273
181030100/0	Thread engine brake cable	Turbo 53 S4QH/ 53 SEV Q B	L1= 1090 - L2= 1313
181030101/0	Thread engine brake cable	Turbo Power 50 SB/ 53 SB	L1= 1012 - L2= 1333
181030084/0	Thread engine brake cable	Multiclip 47 Blue, Multiclip 47 S Blue	-
181030079/0	Thread engine brake cable	Multiclip 47 QB, Multiclip 47 SQB	-

# Lawn Mowers

## Thread Engine Brake Cables

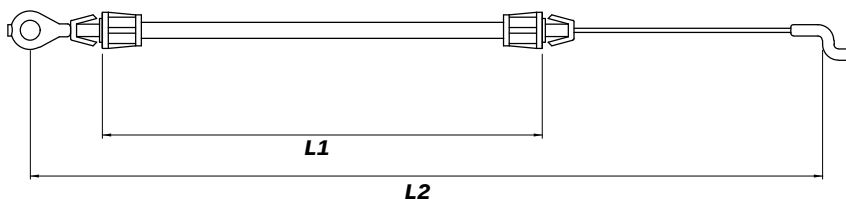

Part Nr.	Description	Fits	Note (mm)
181000631/0	Thread engine brake cable	Multiclip 50 B/ 50 S B (2011-)	L1= 1022 - L2= 1215
181000634/0	Thread engine brake cable	Multiclip 50; Multiclip 50 S (2011-)	L1= 1040 - L2= 1233

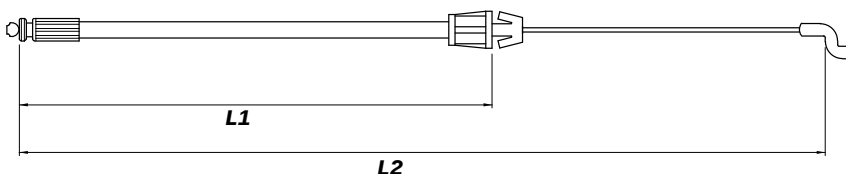

Part Nr.	Description	Fits	Note (mm)
181000685/0	Thread engine brake cable	Dino 47 (2011-)/47B	L1= 935 - L2= 1205

## Rear Drive Cables

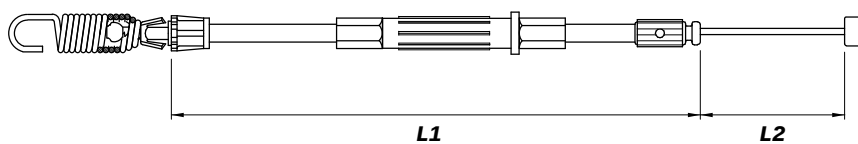

Part Nr.	Description	Fits	Note (mm)
381000697/0	Rear drive cable	Turbo 50 S Rental B/55 S Rental B/50 S Rental H/ Pro 55 4S (2011-)/Pro50 S/Pro55 SB/Turbo Pro 55 S4 B/Pro 50 SB/ Pro 55 SVB	L1= 1300 - L2= 245

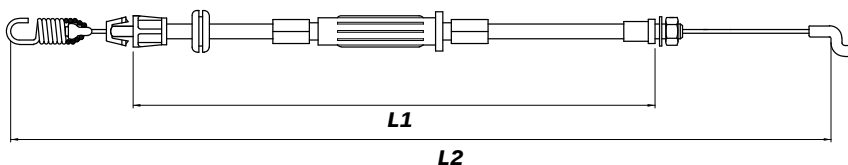

Part Nr.	Description	Fits	Note (mm)
381000734/1	Rear drive cable	Multiclip 50 S; Multiclip 50 S B (2011-)	L1= 1510 - L2= 1774

# Lawn Mowers

## Rear Drive Cables

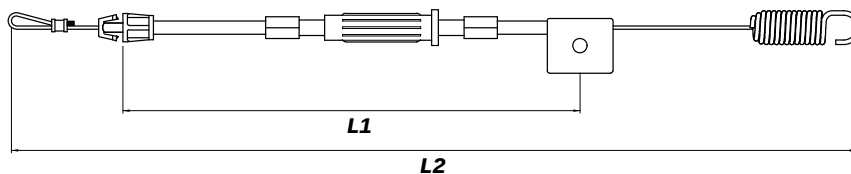

Part Nr.	Description	Fits	Note (mm)
381000745/1	Rear drive cable	Multiclip 50 S Rental B/50 SE Rental B/50 S Special B/53 S Rental B/50 S H/Pro 50 S Svan/Pro 53 S Svan/ Pro 53 4S Svan/50 S Plus/50 S Rental (2011-)/Multiclip Pro 50 S4 INOX Svan/ Multiclip Pro 53 S B/Multiclip Pro 53 SV	L1= 1330 - L2= 1506

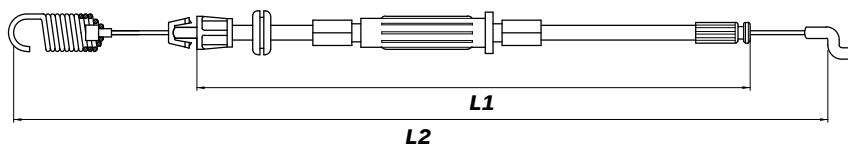

Part Nr.	Description	Fits	Note (mm)
381030067/0	Rear drive cable	Turbo Excel 50 S B/Excel 50 SE B/Excel 55 S B; Turbo X3 50 S; Turbo X3 50 S H; Turbo X3 55 S B (2011-), EXCEL 50 S B/50 S4Q INOX B/55 S H, Excel 55 SQ B	L1= 1130 - L2= 1409
381030068/0	Rear drive cable	Turbo Excel 50 S H AVS/Excel 55 S H AVS/Excel 55 S H BBC (2011-), Excel 55 SVQ H, Excel 50 SVQ B	L1= 1100 - L2= 1414
381030051/0	Rear drive cable	Combi 48 SQ BW/48 SQ BW B /48 S/48 S QB/48 SB/53 S/53 SQ B/53 SB/53 SQ BW/53 SEQ BW/ Combi 53 SQ BW B (2011-)/Collector 48 SB	L1= 1170 - L2= 1361
381030075/0	Rear drive cable	Turbo 48 S BW Plus B/48 S BW Plus H/48 SB/48 SH; Turbo 53 S BW Plus B/53 S BW Plus H (2011-), Turbo 53 S H	L1= 1137 - L2= 1409
381030078/1	Rear drive cable	Turbo Power 50 SB/53 SB/53 SH	L1= 1130 - L2= 1416
381030092/1	Rear drive cable	Combi 48 SQ/48 SQB/48 SQH/ 53 SQ/ 53 SEQ/53 SQB/53 SQH	L1= 1170 - L2= 1366
381030097/0	Rear drive cable	Turbo Power 48 SB/48 SEB/48 SH/53 S4QH/53 SVQ H/53 SEV Q B/Turbo 48 SEV Q B	L1= 1102 - L2= 1398
381030098/0	Rear drive cable	Turbo Power 50 SB/53 SB	L1= 1102 - L2= 1416

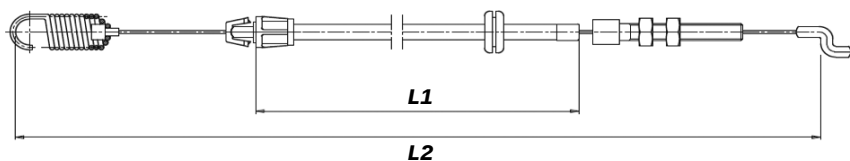

Part Nr.	Description	Fits	Note (mm)
381030012/0	Rear drive cable	Combi 48ES	L1= 1115 - L2= 1379

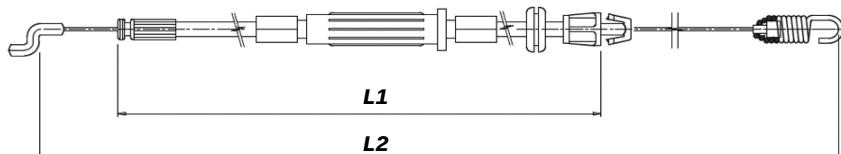

Part Nr.	Description	Fits	Note (mm)
381030082/0	Rear drive cable	Collector 46 S/46 SB/46 SH/53 SB	L1= 1240 - L2= 1412
381030083/0	Rear drive cable	Multiclip 50 S/50SB (-2013)	L1= 1590 - L2= 1762

# Lawn Mowers

## Rear Drive Cables

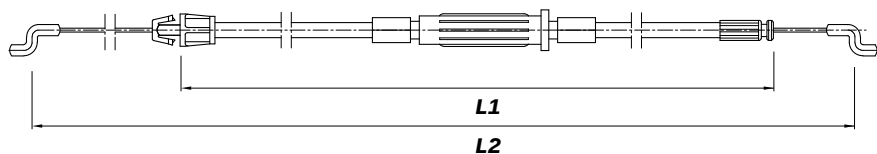

Part Nr.	Description	Fits	Note (mm)
381030096/0	Rear drive cable	Multiclip 50 S Blue/50 S (2014-)/50 SH/47 SQB	L1= 1590 - L2= 1757
381030103/0	Rear drive cable	Multiclip 47 S Blue	L1= 1477 - L2= 1474

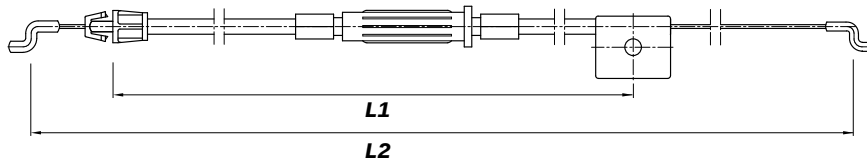

Part Nr.	Description	Fits	Note (mm)
381030095/0	Rear drive cable	Multiclip Plus 50 S/50 SE, Multiclip Rental 50 SB/50 SEB, Multiclip Pro 50 S Svan, Multiclip Plus 50 SEV B	L1= 1330 - L2= 1494

## Speed Control Cable

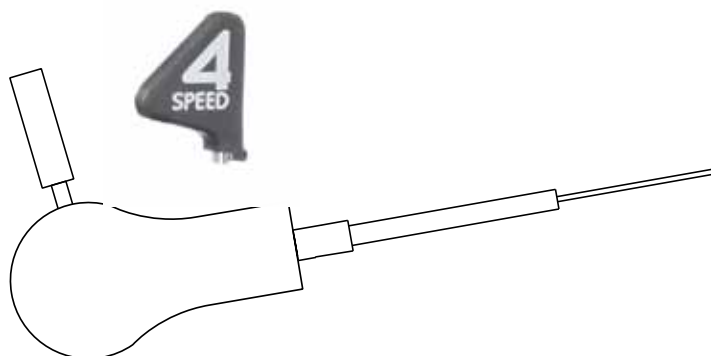

Part Nr.	Description	Fits	Note (mm)
381007098/0	Speed control cable	Multiclip Pro 55 S4B	-
381007112/0	Speed control cable	Multiclip Pro 53 S4 Svan	-
381007110/0	Speed control cable	Turbo 53 S4Q H	-
381007189/0	Speed control cable	Excel 50 S4Q B/55 S4Q H	-

# Front Mowers & Lawn Tractors

## Nuts & Bolts

**Type A**



Code	Pos	Description	Tech info	Fits for
9712-0831-02	1	Lock nut M8 Bolt	-	Villa 102M, Park 102M
9997-0816-16	2	Bolt M8	-	-
1134-9054-01	3	Shear bolt kit	-	-

**Type B**



Code	Pos	Description	Tech info	Fits for
1134-6312-01	1	Lock nut 7/16" UNF	-	Ready 92M, Villa 92M, Villa 107M, Park 92M, Park 107M
1134-6311-01	2	Bolt 7/16" UNF	-	-
1134-9054-01	3	Shear bolt kit	-	-

**Type C**



Code	Pos	Description	Tech info	Fits for
112293201/0	1	Nut do	-	-
9959-0830-16	2	Blade bolt	-	-
9991-1024-19	3	Blade bolt	-	-
1134-0323-01	4	Key	L: 12 mm	-
9600-0150-01	5	Key	L: 16 mm	-
9699-0109-02	6	Flat washer do	-	-
1134-3544-01	7	Fiber washer	-	Garden 72M Multiclip, Garden Combi

**Type D**



Code	Pos	Description	Tech info	Fits for
1134-0400-01	1	Dust cover	-	-
120001215/0	2	Ball bearing-upper	-	-
9945-0825-16	3	Bolt do	Self thread	-
9549-0020-00	4	Ball bearing-lower	-	-

**Type E**



Code	Pos	Description	Tech info	Fits for
1134-3725-02	1	Spacer	L= 9.3 mm	-
1134-3725-01	2	Spacer	L= 12.0 mm	-
1134-3725-04	3	Spacer	L= 25.5 mm	-
9712-1231-02	4	Lock nut M12	-	1134-5052-03, 1134-5052-04
1134-4775-01	5	Lock nut M10	-	1134-4600-01, 1134-4600-02
1134-5130-01	6	Dust cover	-	-

**Type F**



Code	Pos	Description	Tech info	Fits for
1134-5130-02	1	Dust cover	-	Park 107M HD
9549-0056-01	2	Ball bearing	-	-
1134-5124-01	3	Spacer	-	-
9958-0820-16	4	Screw	M8 x 20	-
1134-5127-01	5	Washer	8.5 x 30 x 4	-
9600-0170-00	6	Flat key	6 x 6 x 16	-

**Type G**

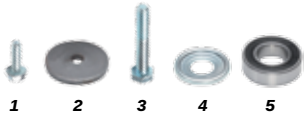

Code	Pos	Description	Tech info	Fits for
9945-0825-16	1	Screw	Self thread	For fixing the bearing box
1134-6211-01	2	Blade washer	-	Villa/Park 85-95-105, Park 100C, Park 110C Pro, Park 125C Pro
9997-1060-12	3	Blade bolt	-	-
1134-5403-01	4	Dust cover	-	-
9549-0057-01	5	Ball bearing do	-	-

# Front Mowers & Lawn Tractors

## Nuts & Bolts

### Type H



Code	Pos	Description	Tech info	Fits for
9945-0825-16	1	Screw	Self thread	For fixing the bearing box
1134-6211-01	2	Blade washer	-	-
9997-1060-12	3	Blade bolt	-	-
120001215/0	4	Ball bearing	-	-

### Type I



Code	Pos	Description	Tech info	Fits for
9945-0825-16	1	Screw	Self thread	For fixing the bearing box
1134-6211-01	2	Blade washer	-	-
9997-1050-16	3	Blade bolt	-	-

### Type J



Code	Pos	Description	Tech info	Fits for
1134-0323-02	1	Key	L = 54 mm	Primo, Combi 78, Combi 90
1134-0323-04	2	Key	L = 45 mm	-
1134-0323-01	3	Key	L = 25 mm	-
9699-0121-02	4	Flat washer	12.5 x 35 x 3	M12-nut
9699-0030-02	5	Flat washer	10 x 26 x 2	M10-nut

### Type K

Code	Pos	Description	Tech info	Fits for
112139100/0	not ill	Key	2 pcs	-
122160400/0	not ill	Elastic washer	-	-
112523080/0	not ill	Washer	-	-
112735695/1	not ill	Screw	CWW	-
112735694/0	not ill	Screw	CW	-

### Type L

Code	Pos	Description	Tech info	Fits for
112794110/0	not ill	Screw	-	-
112540070/0	not ill	Washer	-	-
112793101/0	not ill	Screw	-	-
112523060/0	not ill	Washer	-	-
112155010/0	not ill	Nut	-	-

## Belt Pulleys



Code	Pos	Description	Fits for	Note	Use with Nuts & Bolts
1137-0950-01	1	Belt pulley	78 Combi, 90 Combi	Ø = 141 mm	-
1134-9137-01	2	Toothed pulley	78, 90 Combi, Primo	Kit of 2 pcs.	-
1134-3679-01	3	Toothed belt pulley	Park 92M, 102M, 107M, 121M, Villa 85M, 92M, 102M, 107M, Ready	Outer	Type J
1134-4321-01	4	Toothed belt pulley	Park 92M, 107M, Villa 107M	One half	Type J
1134-9128-02	5	Pulley w/o hub	Park 95C; 105C (2010-)	Only for decks from 2010	-
1137-0116-01	6	Belt pulley	Park 95C (2007-)	Use instead of 1134-9128-01	-
1137-0116-02	6	Belt pulley	Park 105C (2007-)	Use instead of 1134-9128-01	-
1134-3679-02	7	Toothed belt pulley	Park 102M, 121M, Villa 85M, 102M, Ready	Centre	Type J
1134-3419-01	8	Belt pulley	Park 102M, 121M, Villa 102M	Ø = 142 mm	-
1134-5128-01	9	Toothed belt pulley	Park 107M HD	-	-
1137-0006-01	10	Pulley-transaxle	Park, Villa, Ready, Garden	Ø = 154 mm	-
1137-0209-01	11	Centre pulley	Park, Villa, Ready	-	-

# Front Mowers & Lawn Tractors

## Tension Rollers



Code	Pos	Description	Fits for	Note
1134-5048-01	1	Tension roller (steel)	Garden, Scoop	Spacer 1134-5047-01 needed
1134-3663-01	2	Tension roller	Park	-
1134-1322-02	10	Tension roller spring	Park	-
1134-3459-01	3	Tension roller	Park, Park Compact 16, Park 320 M, Park Compact 16 4WD, Park 340 MX, Park Pro 540 IX, Park Pro 740 IOX	-
1137-0209-01	4	Tension roller	Park, Primo	-
1134-1322-01	11	Tension roller spring	Park, Villa	-
1134-9027-02	5	Tension roller	Park, Villa, Garden, Scoop, Primo	-
1134-4686-01	6	Tension roller	Park 92M, 107M, Villa 92M	-
1134-0698-00	7	Tension roller	Park 100B, 110 Combi, 125 Combi, Villa 85B	-
1134-9090-01	8	Tension roller	Villa	-
1134-9091-01	9	Tension roller	Villa, Ready	Fits also 85B, 107M, 110S
1131-1507-00	not ill	Tension roller spring	Villa 320 - 520	-
1134-2989-02	not ill	Tension roller	Villa 320 - 520 - 720 - 13 - 13 HST, Ready	-

## Lifting Devices

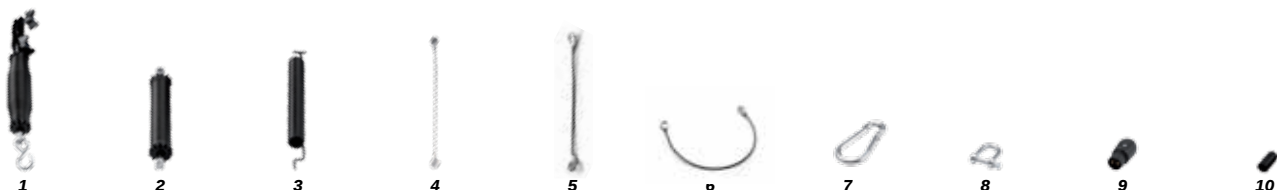

Code	Pos	Description	Fits for	Note
1134-5528-01	7	Snap hook	100 Combi 3 - Park: 95 C, 105 C, 110 C Pro, 125 C Pro - Villa: 85 C, 95 C, 105 C	-
1134-6365-02	2	Lift spring	100 Combi 3 - Park: 110 C Pro, 125 C Pro	L = 237 mm
1134-2629-01	8	Schackle	100 Combi 3 - Park: 110 C Pro, 125 C Pro	-
1134-6182-01	9	Male terminal	100 Combi 3 - Park: 95 C, 105 C, 110 C Pro, 125 C Pro - Villa: 95 C, 105 C	-
1134-5625-01	not ill	Lift spring	Park 95 C - Villa 95 C	-
1134-4688-02	1	Lift spring assy	Park: 92M, 107M, 121M - Villa: 107M	-
1134-3051-01	10	Button	Park: 92M, 95 C, 100M, 102M, 107M, 105M, 110 C, 121M, 125 Combi Pro - Villa: 85M, 92M, 95 C, 102M, 105 C, 107M	-
1134-2314-01	5	Lift wire	Park 100B	L = 262 mm
1134-2535-01	3	Lift spring	Park: 100B, 100M, 102M, 107M, 121M	-
1134-2314-02	5	Lift wire	Park: 100M, 102M, 107M, 121M	L = 302 mm
1134-6365-03	2	Lift spring	Park 105 C - Villa 105 C	L = 222 mm
1134-6565-01	4	Lift wire	Primo	-
1134-2314-03	5	Lift wire	Villa 102M	L = 232 mm
1137-0917-01	6	Lift wire	Villa: 320, 520, 720 (Cutting decks Combi: 78, 90)	L = 1595 mm (total lenght)

## Casing Wheels - Guard Rollers



Code	Pos	Description	Fits for	Note
1134-9139-01	1	Casing wheel	78 Combi, 90 Combi, Primo	-
1134-9140-01	1	Wheel bushing	Primo front wheels	Kit of 2 pcs.
1134-9126-01	2	Support rollers	85, 95, 105 Combi	Kit of 2 pcs.
1134-4284-01	3	Casing wheel	Park 92M, 107M, 125 Combi, Villa 92M, 107M, 85, 95, 105 Combi	-
1134-4319-01	4	Bearing	Park 92M, 107M, 125 Combi, Villa 92M, 107M, 85, 95, 105 Combi	-
1134-4318-01	5	Sleeve	Park 92M, 107M, 125 Combi, Villa 92M, 107M, 85, 95, 105 Combi	-
1134-2405-01	6	Casing wheel	Park 100M, 102M, 121M, Villa 85M, 102M	-
1134-2406-01	7	Guard roller	Park 100M, 102M, 121M, Villa 85M, 102M	-
1134-3434-01	8	Guard roller	Park 100M, 102M, 107M, 121M, 125 Combi	-
1134-5884-01	9	Pivoting wheel	Park 110 Combi, 125 Combi, 107M HD	-



# Front Mowers & Lawn Tractors

## Other



Code	Pos	Description	 Fits for	Note
1134-7465-01	1	Quick connections	Park w. RAC-system	Kit of 2 pcs.
1134-6340-02	2	Foot rest	Park drive pedal	-
1319-1721-01	3	Tine	Park flail mower	1-pc
1319-1772-01	3	Tine	Park flail mower	Kit of 104 pcs.
1811-9013-02	4	Shear bolt	Park 2-stage snow thrower	Kit of 2 pcs.
1139-1415-01	5	Bushing	KTM10, K62 transmission	-
1139-1044-01	6	Seal ring-wheel axle	KTM10, K62 transmission	Ø 25,4 mm
1139-1414-01	7	Bushing	K46, K574 transmission	-
1139-1080-01	8	Seal ring-wheel axle	K46, K574 transmission	Ø 19 mm
1134-4109-01	9	Oil filter	Park Pro 20, Pro Diesel	-
1139-1186-01	10	Oil filter	Park Pro 20, Pro Diesel	-
1134-5962-02	11	Oil filter (paper)	Park Pro 4WD (2007- )	-
1134-5962-01	12	Oil filter (metal)	Park 4WD (2005-2006)	-
1134-9026-01	13	Bronze bearing	Park, Villa	Kit of 4 pcs.
1134-9024-01	14	Plastic bearing	Park, Villa, Garden, Primo	Kit of 4 pcs.
1134-4904-01	15	Hood lock kit	Villa	-
1134-9028-01	16	Rubber strap	Park, Villa	Kit of 4 pcs.
1134-4064-01	17	Tank cap w. gauge	Park	-
1134-3224-01	18	Fuel shut-off valve	Park, Villa, Ready, Scoop, Garden, Villa 320/520	-
1134-3225-01	19	Rubber sleeve	-	-
1134-5532-01	20	Tank cap	Park, Villa, Ready, Primo, Villa 320/520	-

## Electric Parts



Code	Pos	Description	 Fits for	Note
1134-1814-01	1	Ignition switch	Park, Villa, Garden, Scoop ES	Ignition key incl.
1134-4093-01	2	Ignition switch	Park, Villa, Ready, Primo, Villa 320/520	Ignition key not incl.
1134-2962-01	3	Solenoid	Park consumer, Park Consumer High, Park Pro, Primo, Ready, Villa, Ride-on 72, Scoop, Garden	-
1134-3901-01	3	Solenoid	Villa 320/520	-
1134-2848-01	4	Ignition key	Park Consumer, Park Pro, Villa, Estate, Garden, Scoop, Multiclip, Silent, Tornado,	Sold in pairs
1134-3368-01	5	Ignition key	Park Consumer, Park Pro	1-pc.
1134-4734-01	6	Ignition key	Most front mowers	-
9400-0282-01	7	Switch	Park, Villa, Villa 320/520	-
9400-0283-01	7	Switch	Park Pro 20, Pro Diesel	-
1134-3399-02	8	Switch	Park, Villa, Ready, Garden	-
1134-3399-01	9	Switch	Park, Villa	-
1134-2871-03	10	Relay	Park, Villa, Primo, Villa 320/520	5 connections
1134-2871-01	11	Relay	Park, Villa 320/520	4 connections

# Front Mowers & Lawn Tractors

## Cables

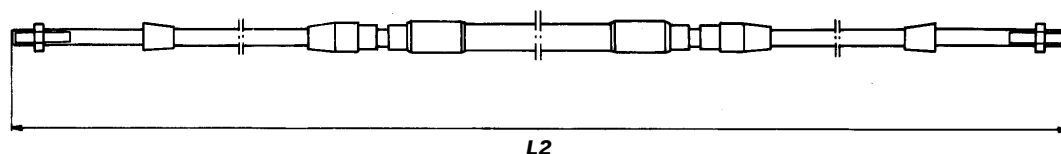

Part Nr.	Description	Fits for	Note (mm)
1134-0280-00	Gearshift cable	Park 2w	L2= 896

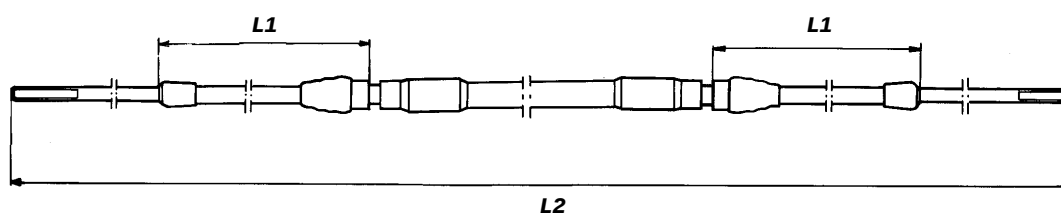

Part Nr.	Description	Fits for	Note (mm)
1134-2031-02	Gearshift cable	Park (1985-99)	L1= 160/134 - L2= 1337

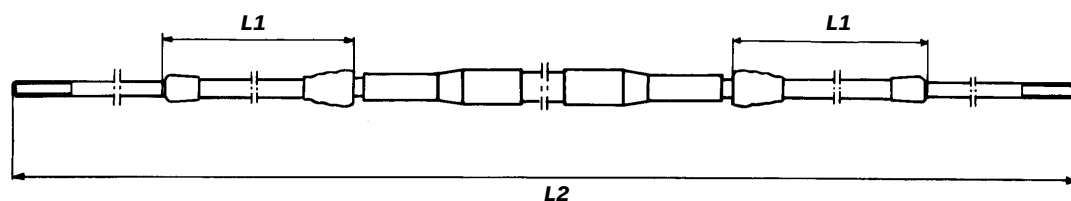

Part Nr.	Description	Tech info	Note (mm)
1134-2766-02	Control cable	Park Pro 16, 18 (1994-99)	L1= 110/134 - L2= 1229
1134-2766-03	Control cable	Park 13HST, President (1994-99)	L1= 160/134 - L2= 1304
1134-2766-04	Control cable	Park Pro 16, 18, 20 (2000-05)	L1= 134/134 - L2= 1310
1134-2766-05	Control cable	Park President, Royal, Compact HST (2000-)	L1= 160/134 - L2= 1250
1134-2766-06	Control cable	Park Senator (2000-03)	L1= 160/134 - L2= 1420
1134-2766-07	Control cable	Park Compact (2004-)	L1= 258/134 - L2= 1489
1134-2766-08	Control cable	Park Pro 4WD (2005-2014)	L1= 100/134 - L2= 960
1134-2766-10	Control cable	Villa 320/520	L1= 100/110 - L2= 1755
187000200/0	Control cable	Park Pro (2015 -)	L1= 1925 - L2= 45

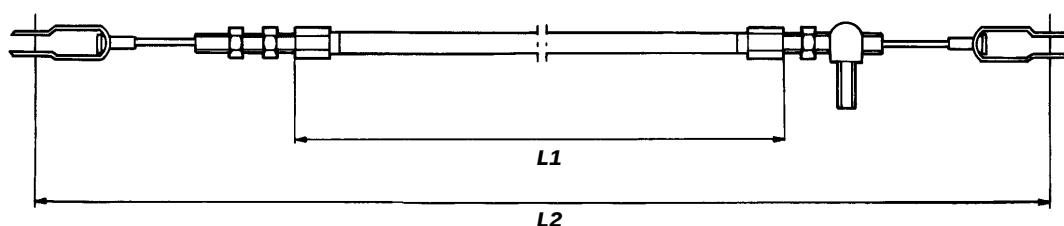

Part Nr.	Description	Fits for	Note (mm)
1134-0226-00	Clutch cable	Park 2000 (1975-84)	L1= 1086 - L2= 1350

# Front Mowers & Lawn Tractors

## Cables

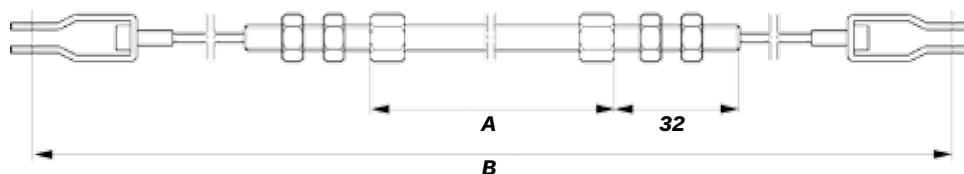

Part Nr.	Description	Fits for	Note (mm)
1134-2030-04	Clutch cable	Park (1985-99)	A= 788 - B= 540
1134-2030-11	Clutch cable	Park 13HST, President (1995-99)	A= 808 - B= 540

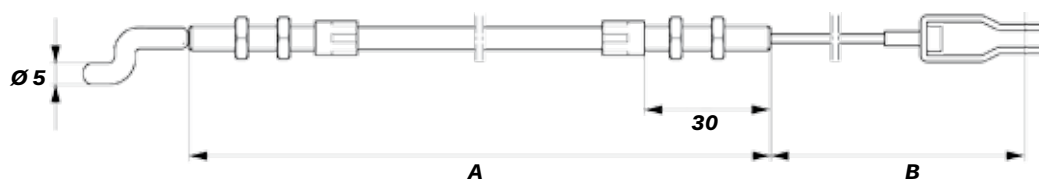

Part Nr.	Description	Fits for	Note (mm)
1134-4058-01	Control cable	Park Senator (2000-03), Park Compact (2004-2008)	A= 680 - B= 150

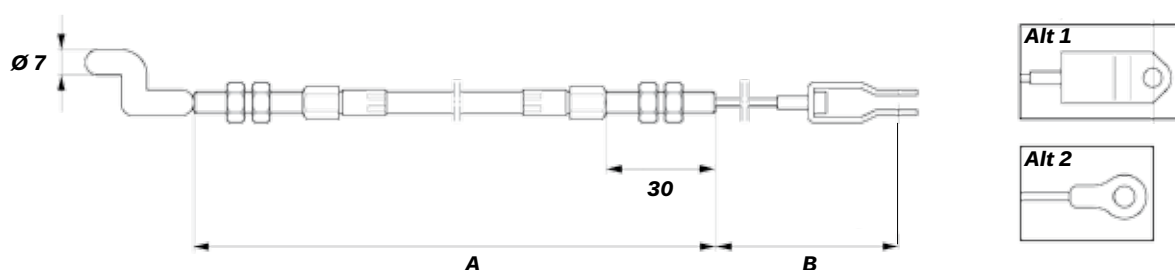

Part Nr.	Description	Fits for	Note (mm)
1134-3573-01	PTO cable	Park (1985-99)	A= 315 - B= 146
1134-3573-02	Brake cable	Park (1989-99), President (1995-99)	A= 884 - B= 179
1134-3573-03	PTO cable	Park (2000-2013)	A= 804 - B= 126
1134-3573-04	PTO cable	Villa II (2003-06)	A= 427 - B= 123
1134-3573-05	PTO cable	Park Compact (2004- )	A= 395 - B= 110
1134-3573-06	PTO cable	Ready (2004-), Villa (2007-)	A= 460 - B= 172

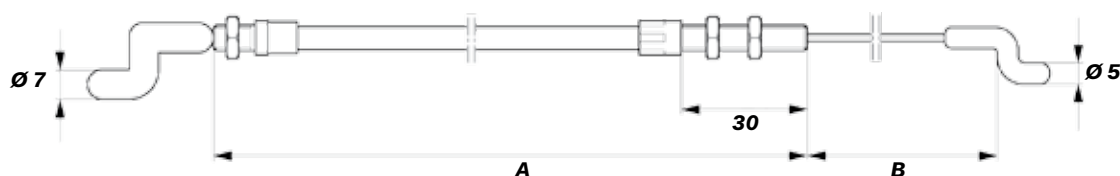

Part Nr.	Description	Fits for	Note (mm)
1134-6005-01	Control cable	Park Compact 4WD (2006-), Prestige (2006-)	A= 755 - B= 280

# Front Mowers & Lawn Tractors

## Cables

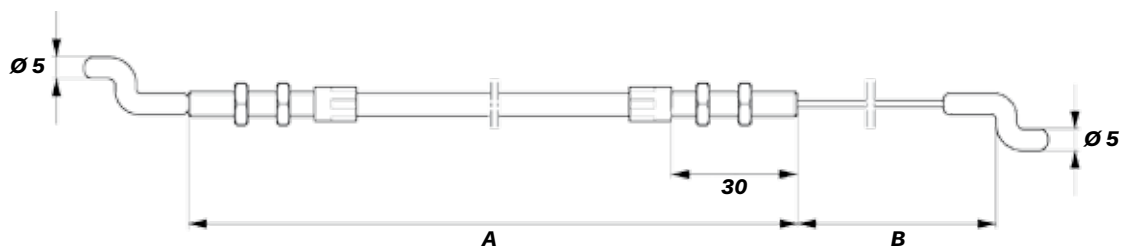

Part Nr.	Description	Tech info	Note (mm)
1134-3584-01	Control cable	Park 16HST, 18HST (1994-99)	A= 800 - B= 200
1134-3584-02	Control cable	Park Pro 16, 18, 20 (2000-05)	A= 840 - B= 150
1134-3584-03	Control cable	Park President, Comfort, Royal and more (2000-2010)	A= 775 - B= 171

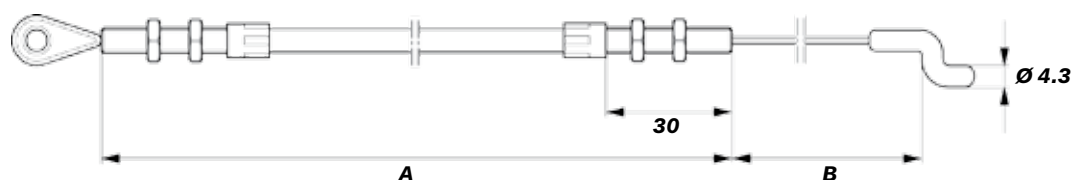

Part Nr.	Description	Fits for	Note (mm)
1134-3410-02	Brake cable	Park (1994-99), Park Senator, Compact (- 2008)	A= 878 - B= 170

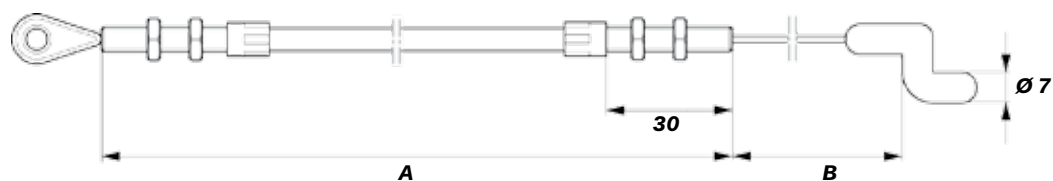

Part Nr.	Description	Fits for	Note (mm)
1134-4006-01	Control cable	Park Pro 16, 18, 20 (2000-05)	A= 1130 - B= 135

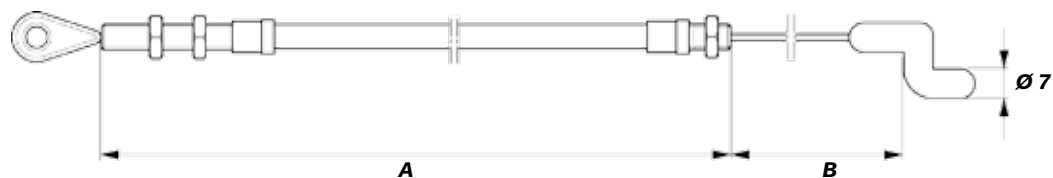

Part Nr.	Description	Fits for	Note (mm)
1134-6020-01	Brake cable	Park Pro 4WD (2006-)	A= 670 - B= 268

# Front Mowers & Lawn Tractors

## Cables

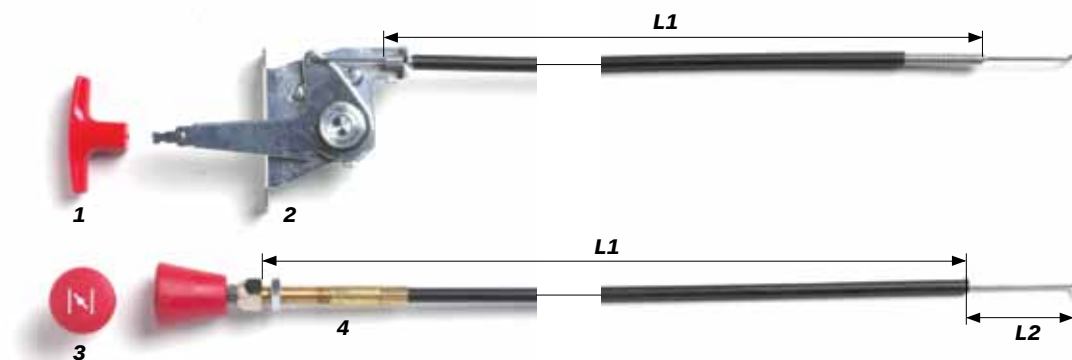

Pos	Part Nr.	Description	Fits for	Note (mm)
1	1134-7284-01	Knob	Not included in the throttle control	-
1	337592150/0	Knob	Park Pro 340X, 540 IX, 740 IOX	-
2	1134-1975-01	Throttle control	Villa I (-2003)	L1= 520
2	1134-1975-03	Throttle control	Park 2000, Park 2002 (1984-85)	L1= 1430
2	1134-1975-05	Throttle control	Garden 6 (1984-92)	L1= 376
2	1134-1975-09	Throttle control	Park 2002, 12 (1986-91)	L1= 1302
2	1134-1975-11	Throttle control	Park 10, 11, 12, 13 (1992-99)	L1= 1250
2	1134-1975-12	Throttle control	Park 16, 18 (1998-99)	L1= 1690
2	187000201/0	Throttle control	Park Pro 340X, 540 IX, 740 IOX (Briggs&Stratton)	L1=1870
2	187000202/0	Throttle control	Park Pro 540 IX, 740 IOX (Honda)	L1=2000
3	1134-4338-01	Knob	Included in the choke control	-
4	1134-2872-01	Choke control	Park (1990-99), Park (2005 -2010 )	L1= 1768 - L2= 42
4	1134-2872-02	Choke control	Park Pro 16, 18, 20 (2000 - 2013)	L1= 1405 - L2= 55
4	1134-2872-03	Choke control	Park Royal, Power (2000 - 2013)	L1= 1509 - L2= 46
4	1134-2872-04	Choke control	Villa Royal (2003-06)	L1= 952 - L2= 46
4	1134-2872-05	Choke control	Park Prestige, Power (2006 - 2009)	L1= 1100 - L2= 55
4	1137-0062-01	Choke control	Park Pro (2010-)	L1= 1693 - L2= 55
4	1137-0062-03	Choke control	Park Ranger, Royal, Excellent (2011-)	L1= 1496 - L2= 59
4	137090200/0	Choke control	Park Pro 340X, 540 IX, 740 IOX	L1= 1925 - L2= 45



Part Nr.	Description	Fits for	Note (mm)
1134-1597-11	Throttle cable	Villa II w. B&S-engine (2001-06)	L1= 568 - L2= 64
1134-1597-12	Throttle cable	Villa II w. Honda-engine (2001-06)	L1= 1106 - L2= 64
1134-1597-13	Throttle cable	Ready (2004-), Villa 12 (2007-)	L1= 680 - L2= 64
1134-1597-14	Throttle cable	Primo (2008 -2013)	L1= 392 - L2= 50

# Front Mowers & Lawn Tractors

## Cables



Part Nr.	Description	Tech info	Note (mm)
1134-4197-01	Throttle cable	Park President, Comfort (2004 - 2010)	L1= 925 - L2= 62
1134-4197-03	Throttle cable	Villa (2007-), Park Compact (2007-), Park Compact (2004-06), Park Compact WM14 (2007)	L1= 1350 - L2= 62
1134-4197-05	Throttle cable	Villa Silent (2009-)	L1= 1400 - L2= 62



Part Nr.	Description	Fits for	Note (mm)
1134-4195-01	Throttle cable	Park Pro 16, 18, 20 (2000 - 2010)	L1= 1413 - L2= 60
1134-4195-02	Throttle cable	Park Royal among others (2000 - 2007)	L1= 1390 - L2= 65
1134-4195-03	Throttle cable	Park Pro (2005 - 2010)	L1= 1713 - L2= 60
1134-4195-04	Throttle cable	Park Prestige, Power (2006 - 2009)	L1= 1070 - L2= 60

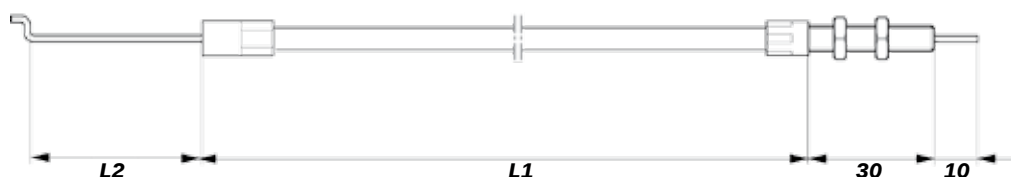

Part Nr.	Description	Fits for	Note (mm)
1134-4923-01	Throttle cable	Park Diesel (2002 - 2014)	L1= 880 - L2= 110
187000203/0	Throttle cable	Park diesel (2015 -)	L1= 880 - L2= 140

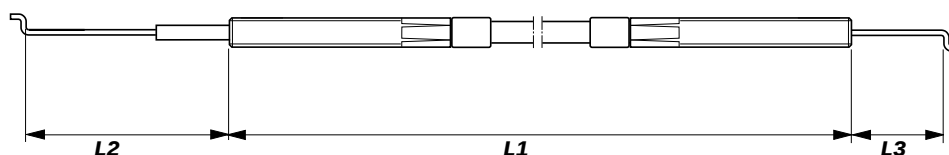

Part Nr.	Description	Fits for	Note (mm)
1137-0063-01	Throttle cable	Park Pro (2010-)	L1= 1693 - L2= 55 - L3= 25
1137-0063-02	Throttle cable	Park Residence, Plus, Prestige (2011-)	L1= 925 - L2= 50 - L3= 20
1137-0063-03	Throttle cable	Park Ranger, Royal, Excellent (2011-)	L1= 1413 - L2= 55 - L3= 25

# Snow Throwers

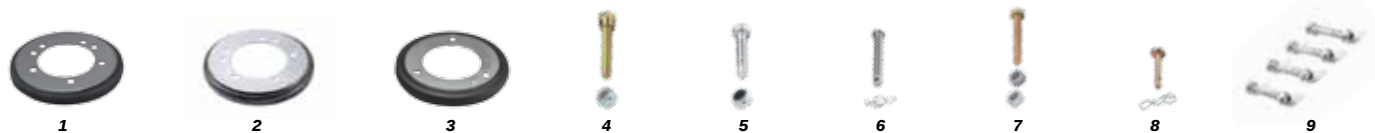

Code	Pos	Description	Fits for	Note
1812-9003-01	1	Friction wheel	828 - 1232 (1983-93)	-
1812-2872-01	2	Friction wheel	1371 - 1581	Kit of 2 pcs.
1812-9028-01	3	Friction wheel	522 - 825 (1983-93), all (1994-)	-
1812-9006-01	4	Shear bolt	Snow flake, Snow Power, ST1030, 1130E, 1384, 1384D, Snow Flake	Kit of 2 pcs.
1811-9012-01	5	Shear bolt	Snow Rise (2006-)	Kit of 2 pcs.
1812-9029-01	6	Shear bolt	966D, 1171HST, 1381HST (2006-)	Kit of 2 pcs.
1812-9005-01	7	Shear bolt	Among others Snow Storm, Snow Blizzard, Snow Hurricane, Snow Track, 866, 1174HST, Snow Spark, Flake, Power, Snow Fox	Kit of 2 pcs.
1811-9011-01	8	Shear bolt	Snow Fall (2004-2005)	Kit of 2 pcs.
1811-2761-01	9	Shear bolt	-	Kit of 4 pcs.

# GGP Engines



Code	Pos	Description	Fits for	Type	CC	Note
318550350/0	-	Engine assy	M 150 Ethanol	SV	150	
118550157/1	-	Engine assy	RM 45	SV	150	
118550732/0	-	Engine assy	RS100	OHV	100	
118550736/0	-	Engine assy	RSC 100	OHV	100	
118550761/0	-	Engine assy	RSTC 100	OHV	100	
118550407/0	-	Engine assy	SA 45	OHV	140	
118550408/0	1	Engine assy	SA 55	OHV	160	
118550410/0	-	Engine assy	SA 55	OHV	160	For Silent lawn mowers
118550411/0	-	Engine assy	SA 55 ES	OHV	160	With electric starter
118550409/0	-	Engine assy	SA 55-T	OHV	160	For tillers
118550318/0	-	Engine assy	SA 65	OHV	196	
118550431/0	-	Engine assy	SA 65 E	OHV	196	With electric starter
118550439/0	-	Engine assy	WM 12,5	OHV	414	
118550451/0	-	Engine assy	WM 14	OHV	432	
118550526/0	2	Engine assy	WM 16	OHV	452	

# Others



Code	Pos	Description	Note
1111-9178-01	1	Kit oil	2 x 0,6 lit. + pump
1134-4452-01	2	Oil change kit	-
118718000/0	3	Oil pump	Included in 1134-4452-01 and 1111-9178-01
1111-9159-01	4	Service kit (Oil, spark plug, air filter)	For GGP-engine 150 cc (V35, SV40)
1111-9172-01	5	Service kit (Oil, spark plug, air filter)	For GGP-engine 140/160/196 cc
9498-0311-02	6	Paint STIGA-grey	0.25 lit.
9498-0311-01	6	Paint STIGA-yellow	0.25 lit.
1111-9118-01	7	Drain plug wrench	3/8"
131240011/0	8	Ethanol additive	MTR-LIFE, 10 x 4 cc

## Special Screw Drivers

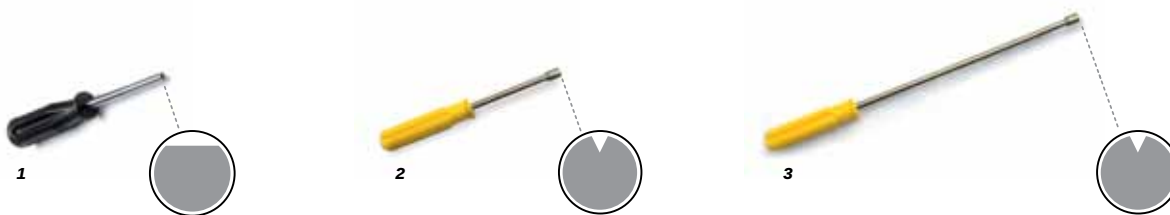

Code	Pos	Description	Fits for
123049000/1	1	Special screwdrivers	SP382, SP 402-422-442, SP 472, SP 350, SP 400, SP 380, SP 482, SP 522, SP 375, SP 405, SP 36, SP 43, SP 46, SP 52, SPR 255, SGT 226J, SBC 226J, SBC 226JD
123049003/0	2	Special screwdrivers	BT 325- BJ 335 - BJ 345 (Mono - Duplex - Flex) - TR 26 - TB 26 - TB 34 (Mono - Duplex) - BL 250 H, TR 250, TB 250, TB 320, TB 420, SBL 327 V
1230499004/0	3	Special screwdrivers	SHJ 550

## Spark Plug Wrenches



Code	EAN	Description	Fits for	Note
1111-9029-01	7313329110309	Engine assy	-	19/21 mm
1111-9029-02	7313329110941	Engine assy	-	5/8" (16 mm)/21 mm

## Belt Holders



Code	Fits for
8290-0065-01	Belt holder
8290-0066-06	Label kit (sheet nos. 1-8)
8290-0087-01	Label kit (sheet no. 9)
8290-0087-02	Label kit (sheet nos. 10-11)
8290-0087-03	Label kit (sheet no. 12)
8290-0087-04	Label kit (sheet nos. 13-)



# Service Tools

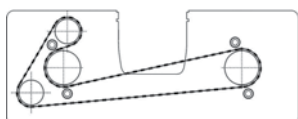
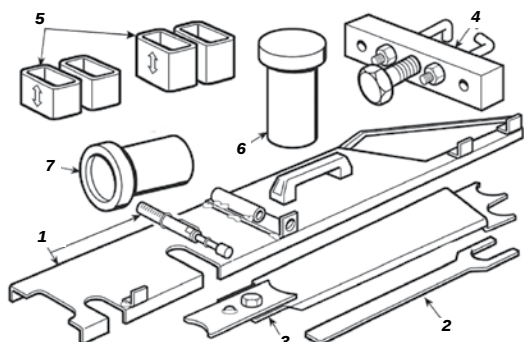

1

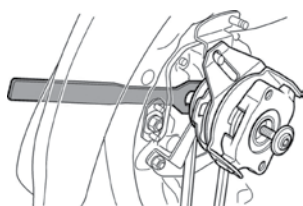

2

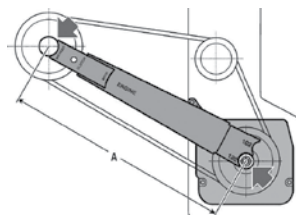

3

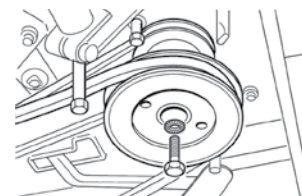

4

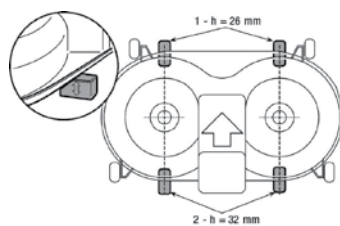

5

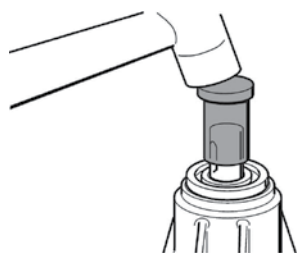

6

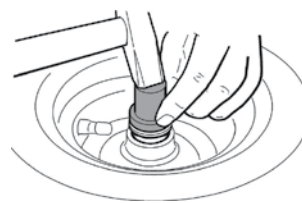

7

Code	Pos	Description	Fits for
382180081/0	1	Blade connection belt tension checking template	102, 122
382180080/0	2	Wrench for dismantling the clutches	63
382180079/0	3	Pulley centre distance checking template	102, 122
382180078/0	4	Pulley extractor	72, 92, 98, 102, 122
382180077/0	5	Blocks H= 26 mm for adjusting the cutting deck Blocks H= 32 mm for adjusting the cutting deck	63, 72, 92, 98, 102, 122
382180076/0	6	Bush for assembly of blades bearings	63, 72, 92, 98, 102, 122
382180075/0	7	Stopper for assembly of wheel bearings	72, 92, 98, 102, 122





**STIGA**

[www.stiga.com](http://www.stiga.com)